



2018 MEN'S GAME

THREE-PERSON MECHANICS MANUAL



ACKNOWLEDGEMENT

This manual is the result of the hard work and collaboration of the Men's Officials Development Task Force and the staff of US Lacrosse that supports this group. It should be used as a resource for individuals and organizations alike. Knowledgeable competent officials are the cornerstone for the development of lacrosse across the country. It is our hope to continue to develop nationally standardized mechanics, so as team and officials travel across the country to play and officiate, that they will have encounter the same level of officiating and mechanics that ensures safety and fair play.

***Kevin Curley - Men's Officials
Task Force Chair***

*Bob Hutchinson, NY
Jason Rhodes, TX
Paul Kunzel, CA
Josh Blaisdell, MA
Nate Hoeckelman, KS*

***Gordon Corsetti - US Lacrosse Manager,
Men's Officials Development***

*Sean Murphy, NH
Spike Decker, NY
Bill Devine, VA*

SPECIAL THANKS

These volunteers helped the Men's Officials development program create new resources this past year:

Matt Palumb, David Malmquist, Jim Carboneau, Greg Hite, Ronald Kramer, Tim Bohdan, JP Politano, Clark Bell, Adam Pietrocarlo, Micahel Williamson, Chris Petron, David Seidman, Walt Munze, and PJ Calello

ABOUT THIS MANUAL

This manual is designed to be a supplement to the US Lacrosse on-line course, classroom and on-field training. It is not the end-all-be-all of lacrosse officiating, but more of a guide and resource for officials to carry with them in their game bag throughout the season.

The manual is composed of four main sections.

INTRODUCTION

Resources and information related to all levels of officials. Briefly outlines the training and certification requirements established by US Lacrosse and includes a list of resources established specifically for men's game officials by US Lacrosse.

THE GAME

Follows along directly with the national standard for officiating mechanics and the classroom PowerPoint your local US Lacrosse Certified Trainer will go through annually in your classroom section.

GAME MANAGEMENT

Information and resources that go beyond the basics.

APPENDICES

Additional resources and information from US Lacrosse that is invaluable to officials of all levels.

INTERACTIVE LAYOUT

The layout of this manual is to assist officials in utilizing this valuable tool throughout their season and career. We have added a notes section, rule references to the three main rule codes, and Quick Response Codes (better known as QR codes) to allow officials to access resources by a simple click or utilizing a free QR code reader on their smartphone.

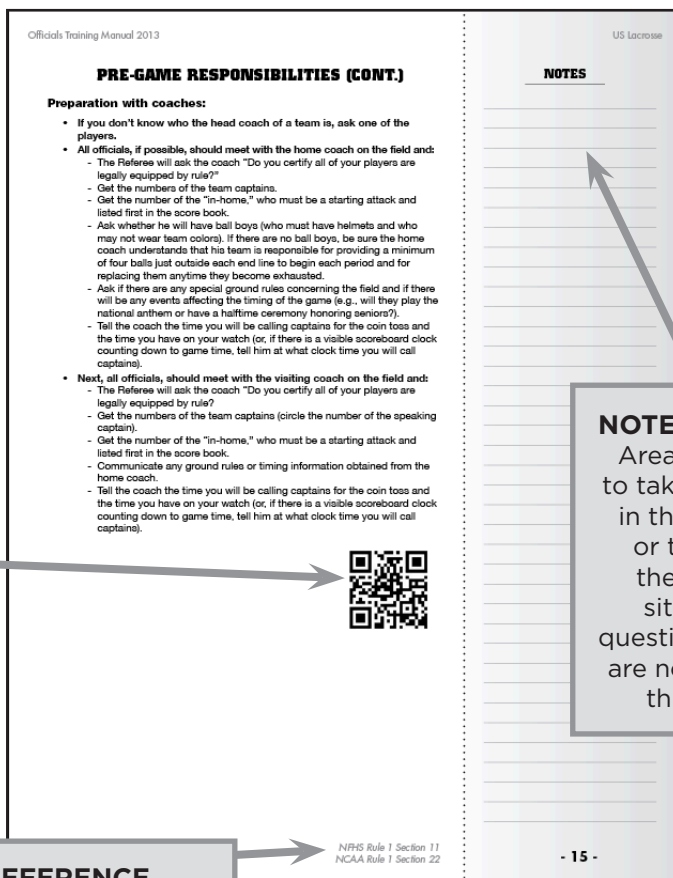

QUICK ACCESS CODE (QR CODE)
 You can access the link by either clicking on this (if viewing as a PDF on your computer) or by using a free QR Reader on your smartphone.

NOTES SECTION
 Area for officials to take notes while in the classroom or throughout the season as situations or questions arise that are not covered in this manual.

RULE REFERENCE SECTION
 References the US Lacrosse Youth Rules, NFHS and/or NCAA rules related to the information on the page

CONTENTS

Acknowledgments.....	iii
About this Manual	iv
Contents	v
INTRODUCTION	1
US Lacrosse Men's Game Officials Training	2
Professionalism.....	6
Uniform and Equipment.....	7
THE GAME.....	9
Glossary of Officiating Terms.....	10
The Field of Play	11
Mechanics	12
Pre-Game Responsibilities	13
Coin Toss	16
Pre-Game Line-Up	17
Faceoffs	18
Settled Situations	21
Stopping and Starting Play	23
Goal Scored and Readyng the Ball for Faceoff After Goal.....	25
Out of Bounds.....	26
Deep Restarts.....	27
Penalty Enforcement.....	29
Fouls Decision Tree.....	31
Play-On	32
Over and Back	33
Equipment Checks	35
Timeouts.....	38
Fight Procedures.....	39
Post-Game.....	40
Arm Signals.....	41
APPENDICES	46
Appendix I - Available Training Tools.....	47
Appendix II - How Officials Honor the Game	48
Appendix III - US Lacrosse Code of Conduct.....	49
Appendix IV - US Lacrosse Benefits for Officials.....	50



INTRODUCTION

US LACROSSE MEN'S GAME OFFICIALS TRAINING

As the sport of lacrosse grows and evolves, so do the rules and mechanical procedures at all levels of the game. The purpose of the US Lacrosse Officials Development Program is to develop knowledgeable and prepared lacrosse officials at every level of the game.

In order to achieve this, officials must:

- Undergo continued standardized training in order to stay current with the game
- Always consider the level of play when officiating
- Promote the safety of participants
- Promote fair play and sportsmanship
- If desired, work to improve their certification level and qualify for higher level games and “move up” to higher levels of officiating



MEN'S OFFICIALS INFORMATION

US Lacrosse training has been developed – and continues to improve – with these goals in mind.

CONSIDERING LEVEL OF PLAY

The US Lacrosse Officials Development Program is designed with consideration for officiating at different skill levels. While there are many similarities from level to level, from an emphasis on safety and sportsmanship to the mechanics for basic field positioning, there are many important differences, including – but not limited to – the rules. Lesson plans will be available to certified trainers to guide their instruction by level of play, based on differences in rules, interpretations, and points of emphasis from one level of play to the next. It is important that officials understand and embrace these skill differences when officiating at each level of play.

CAREER PROGRESSION

Officials trained at Levels 1 and/or 2 are sure to find opportunities to officiate youth or scholastic games in their first few years. It takes a few years to develop a strong Level 2 official and usually another few years to develop a strong Level 3 official. Once an official is Level 3 certified, application may be considered for the college ranks. After attaining a college-level ranking, opportunities to officiate post-collegiate club and international lacrosse games await the experienced and dedicated lacrosse official. Opportunities for advancement differ from region to region; ask your local USL Trainer about the requirements for career progression in your district.

HANDS-ON EXPERIENCE

In addition to your local training, US Lacrosse Officials Development Programs provide additional clinic opportunities that take place around the country. Your USL Trainer will share information with you regarding participation in these opportunities. US Lacrosse also sponsors development clinics to meet these needs at a more national level. These clinics utilize regional lacrosse tournaments and summer lacrosse camps as sites for intense and concentrated lacrosse officiating development. The philosophy behind the clinic program is to make them accessible to all lacrosse officials from around the country. This balanced representation enables officials from developing and established areas, to polish their officiating skills under the instruction of a USL Clinician.

There are distinct advantages to LAREDO training programs:

- Officials gain access to appropriate levels of competition when they are ready for advanced training.
- New officials can gain additional more advanced two- and three-person experience.
- Established officials can upgrade their three-person skills through regional lacrosse tournaments, and advanced officials can further polish their techniques by participating in elite tournaments.
- The nationwide standardization of mechanics and rules interpretations are reinforced.
- Knowledge is multiplied, as officials return to their respective US Lacrosse Districts and share their advanced officiating experiences with their colleagues.
- Camaraderie develops as officials interact on national crews.
- Officials gain national exposure.
- Many opportunities are available to you—please work with your local trainer to find out more about how to maximize your officiating experience and opportunities.



CLINICS

US LACROSSE MEN'S GAME OFFICIALS TRAINING

- To promote the safety of all parties (players, coaches, bench personnel, officials).
- To promote fair play and sportsmanship.
- To standardize officials mechanics.
- To recruit, train, and retain officials who are providing a safe and fun game experience at every level they officiate.
- To encourage the growth of the sport and to honor the game.

LEVEL 1

GOALS AND OBJECTIVES OF US LACROSSE LEVEL 1 TRAINING

US Lacrosse Level 1 training is targeted at officials with little or no experience in officiating men's lacrosse. The goal of Level 1 Training is to introduce officials to the basic rules and mechanics necessary to facilitate a safe and fair game. Level 1 Training is primarily intended to equip officials to work games at the 14U scholastic level and lower youth levels.

Level 1 training prepares officials to:

- Properly prepare individually and with a partner in advance of contests.
- Maintain a safe playing field at each contest.
- Establish an assertive presence on the field.
- Communicate effectively using voice and hand signals:
 - With a partner.
 - With coaches and the scorer's table.
- Conduct the pre-game coin toss and line-up procedures.
- Understand and correctly demonstrate basic field positioning.
- Correctly identify if a team has possession of the ball in a penalty situation and how to apply the slow whistle technique.
- Understand and recognize differences between personal and technical fouls.
- Recognize and assess safety fouls accurately and fairly.

LEVEL 1 CERTIFICATION REQUIREMENTS

- Current "official" member designation with US Lacrosse
- Complete the Boys' Lacrosse Rules and Penalty Online Course
- Classroom (8 hours minimum)
 - o Three hours minimum focused on mechanics
 - o Five hours minimum focused on rules and lacrosse officiating knowledge
- Field work (no time limit, needs to pass level 1 evaluation) –
 - o Recommended 2 games as a shadow, 2 games being shadowed, and 2 games solo with senior partner. (Evaluation should be done without a shadow)
 - o It may be necessary to evaluate one official multiple times before certification is achieved
 - o Evaluation reported by trainer as completed and passed to US Lacrosse
- Pass the US Lacrosse annual rules test with an 80% or higher

In addition all officials who are Level 1 Certified and wish to remain Level 1 must meet annual recertification requirements in order to maintain their Level 1 Certification. These requirements are:

- Pass the annual US Lacrosse Rules test with an 80% or higher
- Classroom (6 hours minimum)
 - o Two hours minimum focused on mechanics
 - o Four hours minimum focused on rules and lacrosse officiating knowledge

US LACROSSE MEN'S GAME OFFICIALS TRAINING

LEVEL 2

GOALS AND OBJECTIVES OF US LACROSSE LEVEL 2 TRAINING

Level 2 training is targeted at men's lacrosse officials with field experience and an understanding of basic rules and mechanics. The goal of Level 2 is to advance officials' knowledge and application of rules, mechanics and game management. Level 2 Training is primarily intended to equip officials to work games at the high school level and lower.

Level 2 training reinforces Level 1 concepts and prepares officials to:

- Maintain a safe playing field at each contest
- Establish a confident, professional and assertive presence on the field
- Communicate effectively with a clear, commanding voice and with demonstrative hand signals:
 - With a partner
 - With players
 - With coaches and the scorer's table
- Understand and correctly demonstrate advanced field positioning
- Correctly perform equipment inspections
- Properly enforce the rules regarding 10- and 20-second counts
- Apply the stalling rules
- Correctly identify which team has possession of the ball in a penalty situation and the sequence of fouls as they occur
- Understand, recognize and assess all fouls, including simultaneous fouls and fouls that create an advantage
- Recognize advantage/disadvantage in loose ball situations and when the play-on technique is required
- Assess all fouls accurately and fairly

LEVEL 2 CERTIFICATION REQUIREMENTS

- Must have a current Level 1 certification or have met all requirements for Level 1 certification and is being field evaluated for Level 2 certification.
- Current "official" member designation with US Lacrosse
- Classroom (6 hours minimum)
 - o Two hours minimum focused on mechanics
 - o Four hours minimum focused on rules and lacrosse officiating knowledge
- Field work - (no time limit, needs to pass level 2 evaluation)
 - o Level 2 on-field evaluation
 - o Evaluation reported by trainer as completed and passed to US Lacrosse
 - o It may be necessary to evaluate one official multiple times before certification is achieved.
- Pass US Lacrosse annual rules test with a 90% or higher.

Additionally, all officials who are Level 2 Certified Officials and wish to remain Level 2 must meet annual recertification requirements in order to maintain their Level 2 Certification. These requirements are:

- Take online and pass the US Lacrosse annual rules test with a 90% or higher
- Classroom (6 hours minimum)
 - o Two hours minimum focused on mechanics
 - o Four hours minimum focused on rules and lacrosse officiating knowledge

US LACROSSE MEN'S GAME OFFICIALS TRAINING

LEVEL 3

GOALS AND OBJECTIVES OF US LACROSSE LEVEL 3 TRAINING

Level 3 training is targeted at men's lacrosse officials with field experience and officials who are currently Level 2 officials. The goal of Level 3 is to advance officials' knowledge and application of rules, mechanics and game management. Level 3 Training is focused on three-person mechanics and is primarily intended to equip officials to work games at the high school level and prepare them for eventually becoming a collegiate official.

Level 3 training reinforces Level 2 concepts and prepares officials to:

- Excel at officiating games utilizing three-person mechanics
- Focus on advanced game management techniques
- Establish a confident, professional and assertive presence on the field
- Communicate effectively with a clear, commanding voice and with demonstrative hand signals:
 - With a partner
 - With players
 - With coaches and the scorer's table
- Learn how to properly mentor and work with Level 1 and 2 officials as the Crew Chief
- Understand, recognize and assess all fouls, including simultaneous fouls and fouls that create an advantage.

LEVEL 3 CERTIFICATION REQUIREMENTS

- Current Level 2 certification
- Current "official" member designation with US Lacrosse
- Classroom - 6 hours
 - o Two hours minimum focused on mechanics
 - o Four hours minimum focused on rules and lacrosse officiating knowledge
- Field work - (no time limit, needs to pass level 3 evaluation)
 - o Level 3 on-field evaluation form
 - o Reported by trainer and reported to US Lacrosse as passed
- Pass the US Lacrosse annual rules test with a 90% or above

In addition, all official who are already Level 3 Certified Officials and wish to remain Level 3 must meet annual recertification requirements in order to maintain their Level 3 Certification. These requirements are:

- Take online and pass the US Lacrosse annual rules test with a 90% or higher
- Classroom (6 hours minimum)
 - o Two hours minimum focused on mechanics
 - o Four hours minimum focused on rules and lacrosse officiating knowledge

PROFESSIONALISM

BEING A PROFESSIONAL MEANS MORE THAN BEING ON TIME AND ATTIRED IN THE CORRECT UNIFORM. MASTERING THE FOLLOWING AREAS WILL HELP YOU PRESENT YOURSELF PROFESSIONALLY:

Conditioning: You must be in shape to meet the demands of the game, in terms of speed and endurance. You can't make the right calls if you can't get into position to make them, or if physical strain is affecting your decision making ability.

Rules knowledge: It can take years to fully understand the rules. Continual review of the rules as an official will help you to develop more quickly.

Mechanics: Officials need to know more than the rules: they also need to know where to go on the field and what their responsibilities are.

Game management: There are many times that officials can keep the game running smoothly without using their flag and whistle. Game management techniques are discussed throughout this manual; master them, and you'll find that officiating becomes much easier.

Communication: Communication is a key aspect of game management. Communicate with your Crew, the coaches, and the bench personnel in a clear and efficient manner.

Conduct: Demonstrate the appropriate demeanor; treat your partner, the table personnel, athletes, and coaches with the respect that you desire to receive. Aloofness, indifference, boredom, and disdain are worse behaviors than nervousness; strive to be engaged at all times.

Confidence: Confidence comes from preparation and experience. You must know the rules, interpretations and mechanics in order to be prepared for any situation.

Focus: Concentrate on what you are doing, and do not lose your focus on the game. Block out distractions and move on to the next situation that is happening in front of you. Don't let thinking about a call you might have missed interfere with getting the next call right.

Consistency: Be the same at both ends of the field.

Courage: You must have the courage to do what is right. Whether it's a difficult call or a difficult "no-call," you won't be a successful official without the fortitude to "get it right!"

Uniform and equipment: As an official, you should have the proper uniform, and it should be neat and clean. You must also have the proper equipment for your level of play. If you don't, you'll be battling a negative impression from the start.

UNIFORM AND EQUIPMENT



SHORTS AND SHORTS



SHORTS AND LONGS



LONGS AND LONGS

UNIFORM REQUIREMENTS

- black hat with white piping
- 1-inch striped collared shirt
- black undershirt
- black belt
- black shorts or pants
- black ankle socks
- black shoes

REQUIRED EQUIPMENT

- whistle (x2)
- yellow flag (x2)
- timer
- measuring tape
- coin
- scorecard
- pencil



UNIFORM AND EQUIPMENT
CHECKLIST



THE GAME

GLOSSARY OF OFFICIATING TERMS

On Official	Official who is watching the ball.
Off Official	Official who is watching the action away from the ball.
Lead Official	Primary responsibility is the goal area (crease and goal line) and end line coverage.
Trail Official	Stays behind the play, helping to keep the ball between him and the Lead official. This official would have the 4-second goalie count (if used); any clearing counts (if used) and would assist the Lead official with any offensive counts (if used).
Transition Count	NCAA: 30-second transition count or NFHS 20-second clearing count and 10-second offensive count.
Goal Area	Defined by the 35-yard by 40-yard rectangle around the goal at the attack end of the field. Attack area is also known as the box.
Goal Line Extended (GLE)	Imaginary line running through the goal line and extending from sideline to sideline.
The Alleys	The 10-yard by 35-yard areas on either side of the attack area.
Play-On	A mechanic and call used to indicate a loose ball technical violation and some violations concerning the crease area and goalkeeper interference.
Clearing Team	The team attempting to move the ball from the defensive end of the field to its offensive end.
Riding Team	During a clear attempt, the team not in possession of the ball.
In-Home	A starting attack-man. If players listed in the official scorebook are listed as Attack, Midfield, Defense, Goalkeeper then he is the first attack-man listed. This person must serve all penalties against his team that are not assigned to a specific player or any time serving fouls called against the coaching staff.
Wing Areas	Lines parallel to the sidelines, 20 yards from the center of the field and extending 10-yards on either side of the midfield line, define this space to the sideline as the wing area.
Player Possession	When a player has control of the ball in his crosse so that he is able to perform any of the normal functions of control, such as carrying, cradling, passing or shooting.
Flag Down	A term used by officials to indicate that there will be a time serving foul.

THE FIELD OF PLAY

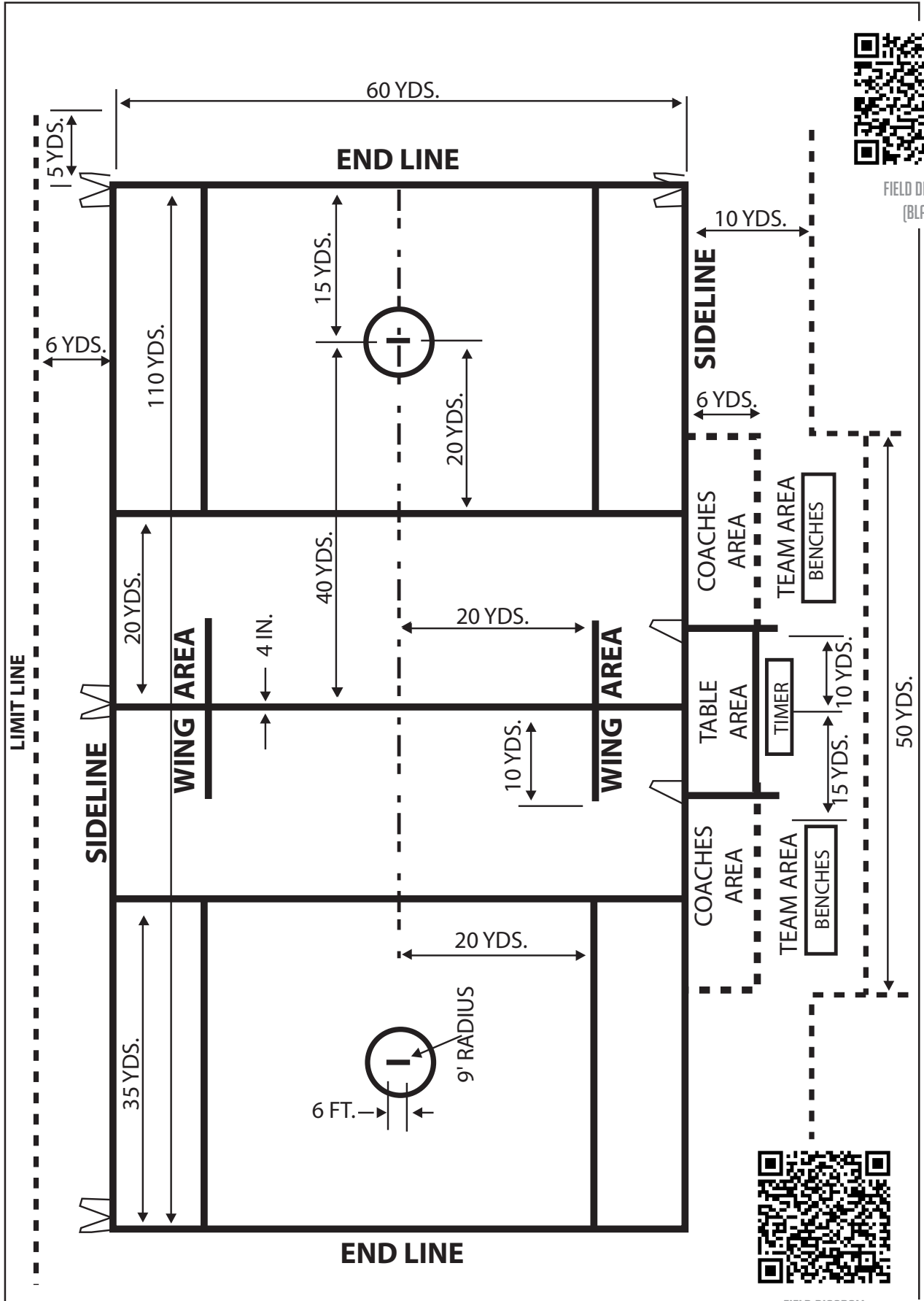

FIELD DIAGRAM (BLANK)



FIELD DIAGRAM (DIMENSIONS)

NOTES

MECHANICS

The term “mechanics” refers to the techniques officials use to accomplish their jobs by knowing the proper positions to be in depending on where the ball and action are on the field. While knowing the rules is an important aspect of officiating, knowing the proper mechanics and where to be on the field allows players, coaches, fans and your partners to understand your calls. By having standard mechanics, it is possible for three officials who have never met before to step onto the field and work together seamlessly.

In three-person mechanics, officials are designated either “Lead,” “Trail,” or “Single.” These designations switch when team possession and field position changes. Depending on where the ball is, either the Lead, Trail or Single can be designated the “on” official (the one who watches the ball); the other two are called the “off” officials and watch activity away from the ball. Responsibilities are divided depending on who is the Lead, Trail and Single; and who is the “on” and “off” officials – so each official is responsible for calling certain rules violations and for watching certain areas of the field. These responsibilities will be covered in detail in the pages that follow.

Typically, each official will rotate across the field from their starting positions at the beginning of each quarter. After each goal, the Single moves to the Lead position and the previous Lead administers the next faceoff while the Trail remains in the same position. The key idea is that no official stays in any one position on the field for an extended period of time.



THREE-PERSON MECHANICS
POWERPOINT

PRE-GAME RESPONSIBILITIES

PERSONAL PREPARATION:

- Uniform and equipment are clean and in good order.
- Review the rules and any modifications covering that game.
- Arrive at the game site with an adequate time cushion. Be ready both physically and emotionally. On the way to the game, mentally prepare yourself; if there is time also do this with your partner
 - Examples of things you may want to discuss with your partner or go over with yourself prior to the game:
 - * *Rule Interpretation*
 - * *Things you are personally working on*
 - * *Situations where you like help*
 - * *Improvements you want to make from previous games*
 - * *Any strange situations you have encountered this season*

COMMUNICATE WITH PARTNERS:

- By telephone or email (24-48 hours before the contest):
 - Confirm the time and location of the game.
 - Confirm the time and location of meeting.
 - Confirm consistent uniform: long pants or shorts; long- or short-sleeved shirt.
- At the meeting site (ideally 45-60 minutes before the contest):
 - The designated Referee for the game should lead the pre-game meeting.
 - Review any new rules for the year and the rule exceptions for this game.
 - Discuss any pertinent information (e.g., field, teams, coaches, weather).
 - Review field mechanics.
- On the field (20-30 minutes before the contest):
 - Enter the field as a team.
 - Be fully prepared and in the appropriate uniform.
 - When greeting and meeting coaches answer any questions or concerns professionally and respectfully.

FIELD INSPECTION:

- Keep safety as your reference point on all decisions.
- Look for safety issues on the field:
 - Holes
 - Mud
 - Water
 - High grass
 - Debris
 - Loose equipment
 - Sprinkler heads
 - Immovable objects near field
- Adjacent areas:
 - The benches should be well behind the coaches’ areas
 - The table should be at least 6 yards from the sideline
 - Spectators must be at least 6 yards from far sideline
 - No spectators are permitted behind the end line
- Check field lines, goals, nets, and creases well before the scheduled start time.
- Re-check the nets just after the coin toss for new holes (created by the teams’ warm-ups) and for balls left in the goal.



PRE-GAME CHECKLIST

NOTES

Do not walk through drills!

NOTES

*Write the name of the
timekeeper on your
scorecard if you do not
know the person.*

PRE-GAME RESPONSIBILITIES (CONT.)

PREPARATION WITH TABLE:

- Table personnel:
 - The home team must provide the official timer and the official scorekeeper.
 - Identify who will perform each role.
 - Do they have experience?
 - * *If they are inexperienced go over their roles and responsibilities*
- Check clock:
 - Is it operational?
 - Will the scoreboard clock be used or will the time be kept at the table?
 - Does the timer know how to operate it?
 - If a scoreboard is used, does the scoreboard have an operational horn that goes off at 'zero'?
 - * *If not, the Referee should explain that the horn should be used when the time gets to 'zero.'*
- Review:
 - Start and stop on whistle.
 - Length of quarters.
 - End-of-period procedure.
- Penalty Clock:
 - Explain your communications with them.
 - Go over the two conditions of release.
 - Cover "early" release procedures.
- Horn:
 - When is a double horn allowed?
 - What if a horn is requested at an improper time?
- If there is a problem:
 - Note who has the ball, where the ball is, and what the problem is,
 - Sound a double horn at the next dead ball,
 - The officials will come to the table to sort out the problem.

PRE-GAME RESPONSIBILITIES (CONT.)

PREPARATION WITH COACHES:

- All officials, if possible, should meet with both coaches, preferably together near the midline of the field and the Referee will:
 - Ask the coach “Are all your players legally equipped by rule?”
 - Get the numbers of the team captains.
 - Get the number of the “in-home,” who must be a starting attack and listed first in the scorebook.
 - Ask the home team coach if there are any pre-game activities or anything out of the norm that might affect the timing of the game (e.g., will they play the national anthem or have a halftime ceremony honoring seniors?).
 - Ask whether the home coach will have ball retrievers (who must have helmets and may not wear team colors). If there are no ball retrievers, be sure the home coach understands that his team is responsible for providing the minimum number of balls according to the rules outside each boundary line to begin each period and for replacing them anytime they become exhausted.
 - Tell the coaches the time you will be calling captains for the coin toss and the time you have on your watch (or, if there is a visible scoreboard clock counting down to game time, tell him at what clock time you will call captains).
 - Ask if either coach has anything further to add.

- Upon completion of the certification and gathering of all necessary information – the Referee delivers the following message:
 - “We would like to request your assistance in emphasizing sportsmanship today. As officials we are required and will enforce all sportsmanship rules for players, coaches and spectators. Good luck today and have fun.”



COACHES CERTIFICATION CARDS



PRE-GAME RESPONSIBILITIES VIDEO

NOTES

If you don't know who the head coaches are look up their names online, or ask one of the players warming up.

NOTES

COIN TOSS

Before the scheduled start time, the Umpire and Field Judge will get the captains at the corner of the box, bench side on their respective halves of the field. The Referee will be at Center "X". No official should use a whistle yet (whistles should not be used until bringing teams onto the field for the line-up). Upon the signal from the Referee, the Umpire and home captains will walk out to the Referee, and then the Field Judge will follow with the visiting captains. This will give the Referee time to introduce himself to the captains.

At the center, the **home captains face the table area** and the visiting captains face away. The Umpire and Field Judge will stand opposite and facing the Referee.

The **Referee** speaks to the captains:

- Introduces the officiating crew.
- Asks the captains to introduce themselves to each other.
- Explains any special ground rules for the game before the coin toss
- Presents a coin and shows each captain which side is heads and which side is tails.
- Explains that he will flip the coin and catch it (without turning it over after it is caught) and that if the coin is dropped it will be flipped again.
- Asks the visiting captain to select "heads" or "tails" before he flips the coin, and the Umpire repeats the selection out loud.
- The team that wins the toss shall receive choice of which goal to defend or control of the first alternate possession. The referee has the captains turn and face the goal they will be attacking.
- The referee directs the captains to return to their benches and tell their teams:
 - Be prepared to begin the game when called.
 - When the teams take the field, to line-up with the goalkeeper positioned so that his left shoulder is closer to the goal he is defending. The rest of the team lines up next to the goalkeeper in the order defense, then midfield, then attack.

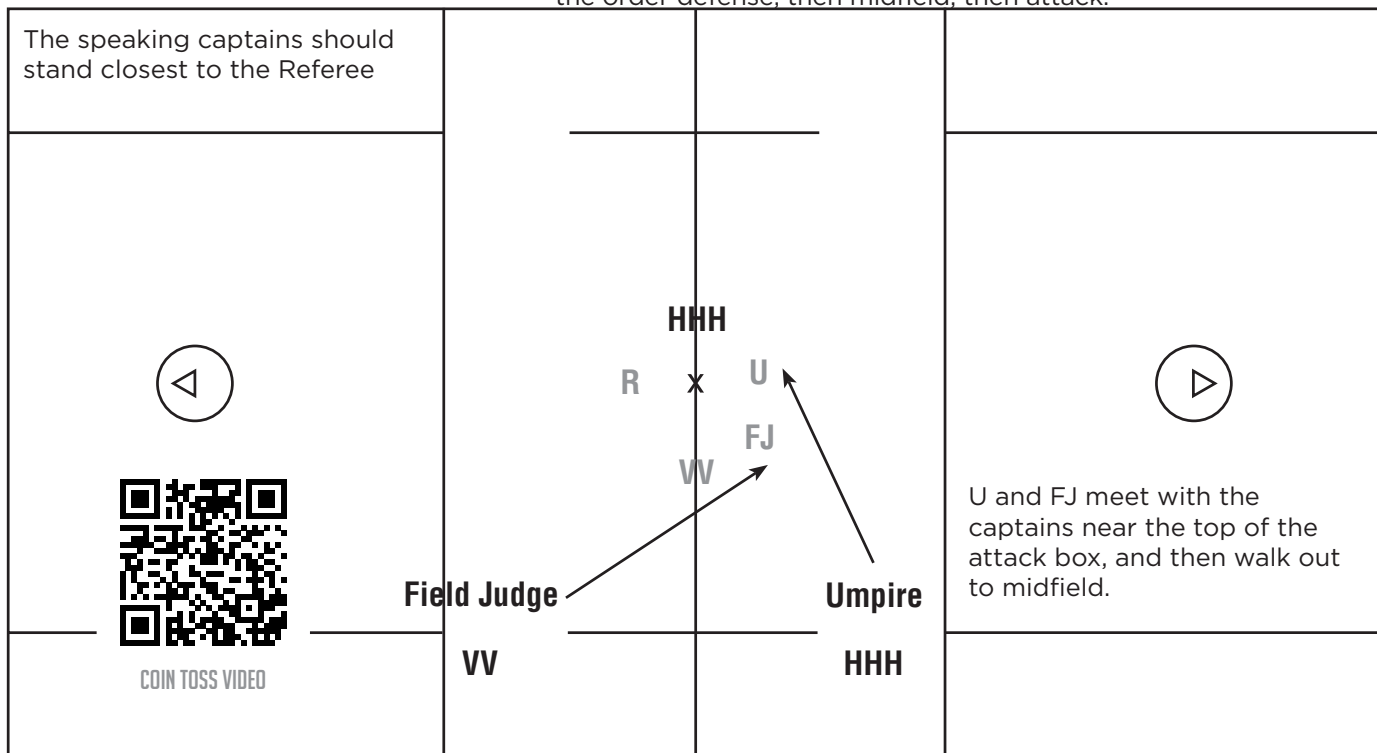

Bench Side

PRE-GAME LINE-UP

For the line-up, the Referee has the game ball and stands at approximately midfield. The Umpire and Field Judge face the Referee on the other half of the field.

The Referee sounds the whistle, signaling both teams to come to the center.

As the players approach, the Umpire and Field Judge help direct the players to their proper line up positions. It is best to begin with the goalkeepers and then the field players in order. The goalkeeper stands with his left shoulder near the goal he is defending. Also ensure the team's in-home player is in the line-up.

Once set, the Referee introduces the crew and says any necessary introductory words of greeting or caution (e.g., warnings about field conditions). These remarks should be as brief as possible.

The Referee instructs the goalkeepers to come together and shake hands.

Once the goalkeepers are out of the way, the Referee instructs all other players to shake hands and then move to their positions.

The Umpire and Field Judge go to their spots for the opening faceoff. They immediately hold one hand up in the air signaling "wait" while they count the players on their half of the field and make sure all is ready for the opening faceoff. When certain all is ready, they give the "ready signal" by dropping their hands and pointing in the direction of the goal they will cover.

NOTES

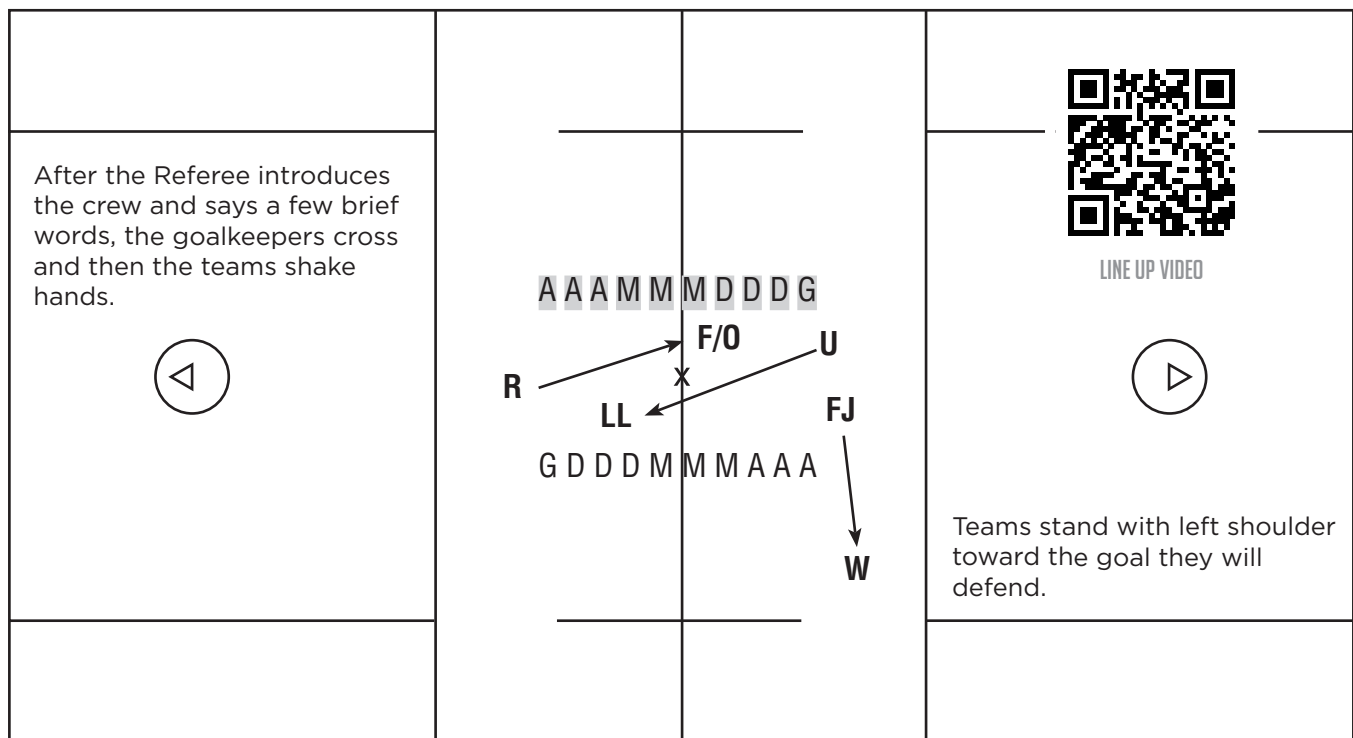

Bench Side

NOTES

No need to be in a rush.

Lead left gives quick verbal adjustments to the players and then backs away.

FACEOFFS

If a faceoff is to begin the quarter the officials will rotate so the Referee conducts the first faceoff in the 1st and 4th quarters. If the faceoff is after a goal, the official who was the Lead conducts it.

THE FACEOFF OFFICIAL:

- Holds the ball
- Writes the number of the goal scorer on his scorecard (if there is a goal).
- Looks to the Lead Left official for the “ready” signal (either a point or verbal statement)
- Makes sure the players at center have their backs to their goalie.
- Indicates where the faceoff will take place by placing tip of shoe on the spot along the midline and instructs the players to prepare for the faceoff by saying “down.”
- Visually checks that both players have:
 - Both hands around the shafts.
 - All fingers touching the ground.
 - Hands off the head of the stick.
 - Sticks parallel to center line.
 - Sticks up to, but not touching, the center line.
 - Heads of sticks are vertical and evenly matched.
 - Entire bodies to the left of the throats of their sticks, so that the neutral zone is clear.
- May physically adjust the players’ positioning (including crosses).
- Places the ball on the ground, in between the head of each crosse.
- Gives “Set” command with his hand on or near the ball or crosses.
- Backs away and sounds the whistle while concentrating on the faceoff players’ actions, moving with the play as necessary.

THE LEAD LEFT OFFICIAL:

- Takes a position diagonally across from the faceoff official and leading to his left (the goal he is responsible for).
 - Adjusts positioning to or further from Center “X” depending upon team’s faceoff tendencies, positioning of wing midfielders on his half of the field, and his own mobility.
- Writes the number of the goal scorer on his scorecard (if there’s a goal).
- Once the bench side wing official gives the “ready” signal give the same signal to the faceoff official when ready.
- May verbally instruct players or inform the faceoff official of any incorrect player position. Should not physically move players.
- Watches for pre-and post-whistle faceoff violations and makes those calls if he sees a violation.
- Covers goal if the ball comes toward his half of the field.

FACEOFFS (CONTINUED)

FACEOFF VIOLATIONS

- Pre-whistle - the official first witnessing the violation stands the players up without a whistle, signals and states the violation.
- Post-whistle - the official first witnessing the violation blows the whistle immediately, signals and states the violation.
- The Faceoff Official will always restart play and take the count.

THE BENCH SIDE WING OFFICIAL

- Pumps fist and starts timer when faceoff official reaches Center "X"
- Takes a position at or near the top of the attack box on his half of the field.
- Writes the number of the goal scorer on his scorecard (if there's a goal).
- Alerts his partners of any man-down situation, and advises the timekeeper to not release any penalties until possession is declared.
- Gives the "ready" signal to the F/O and LL by pointing to the goal he is covering when player count is correct.
- Watches for wing midfielders leaving too soon and any interference away from the faceoff.

POSSESSION AND PLAY:

- If a player gains possession of the ball the on official will wind his arm backwards and yell "Possession!"
- The other officials will echo their partner's call when it is made by winding their arms backward and yell "Possession!" (this is so the entire field knows that the faceoff is over).
- Once possession is established the Single takes the transition count.
- If a loose ball crosses the restraining line the official witnessing it first will wind his arm backward and yell "Play," and the other officials will echo the call and the signal.



BALL TOWARD LEAD LEFT OFFICIAL

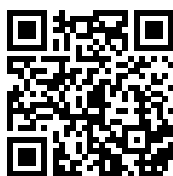

BALL AWAY FROM LEAD LEFT OFFICIAL

NOTES

Be sure there is clear possession! If you release the players early you could have a scrum of 12 players instead of 6

FACEOFF BALL GOES AWAY FROM LL

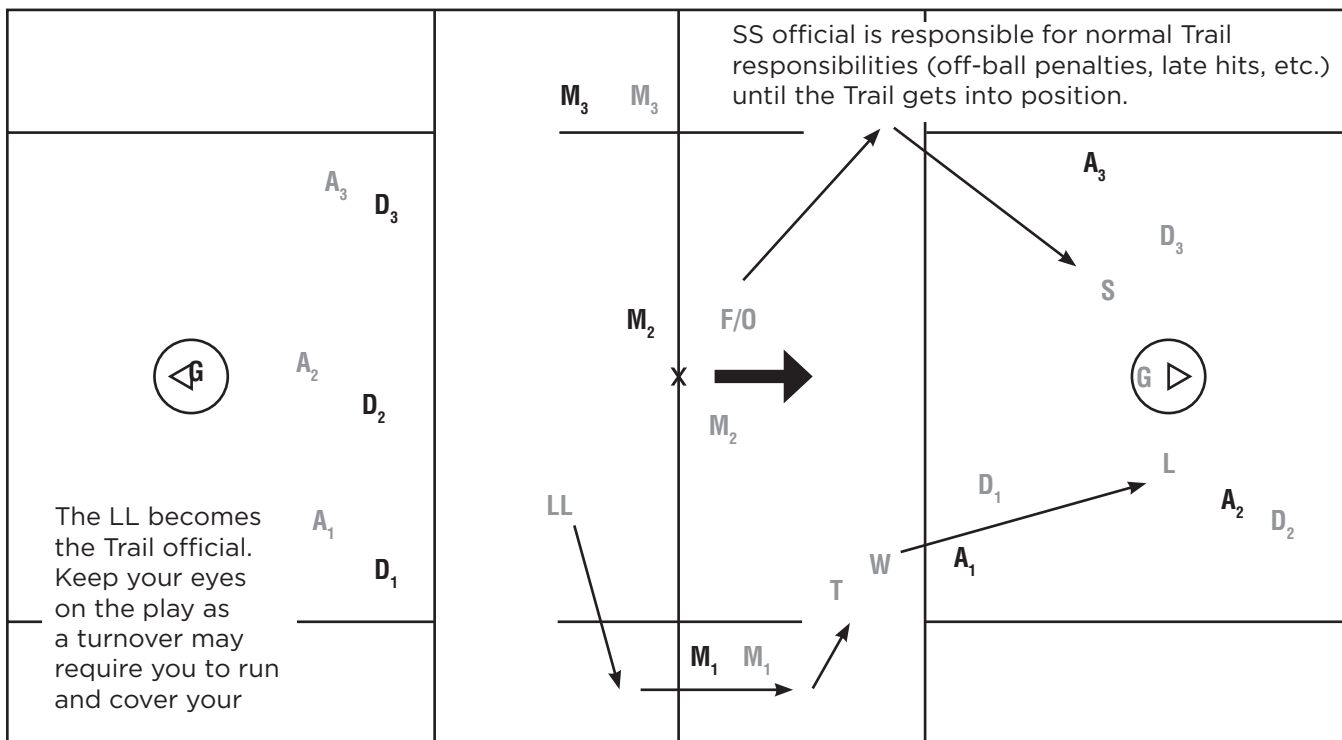

Bench Side

FACEOFF BALL GOES TOWARDS LL

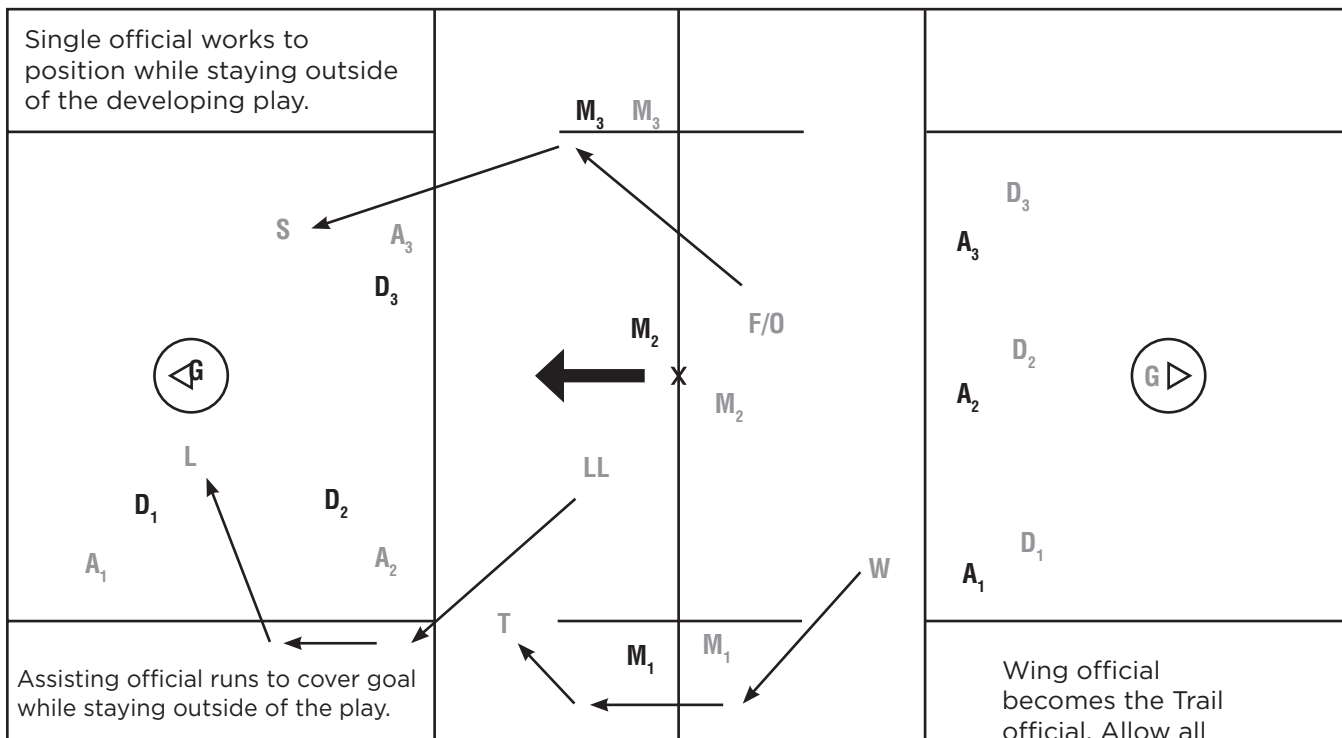

Bench Side

SETTLED SITUATIONS

The key to proper coverage during settled play is to maintain a wide triangle, which allows the crew to keep the play in their lines of vision. Each position has specific responsibilities, and each has backup responsibilities as well, in the event that the primary official is unable to make the call.

As in two-person mechanics, there are dynamic responsibilities based upon which official is the “on” official, usually the official closest to the ball. In three-person mechanics, it is expected that the “on” official covers the ball/ball carrier, while one partner covers action behind the play (e.g., late hits), while the other partner is looking ahead of the play for the next cut, next slide. Specific responsibilities are highly dependent upon game situations and good teamwork is essential to covering the field.

THE LEAD:

- Has the goal as the primary responsibility.
- Should start on goal line extended (GLE) and work for the best angle to see the goal line, net and ball.
- Should move in and out with the flow of the players and the ball.
- Should stay as close to the goal as possible without interfering with the play.
- Responsible for contested plays at or near the end line, and should follow the play to get the best view.
- Has end line responsibility on any shot (chases shots to the end line!).

THE SINGLE:

- Primary responsibility is the action in front of the crease.
- Responsible for watching for late hits after the shot.
- Responsible for the far sideline and all transition counts.
- Covers the goal by moving toward GLE if the Lead runs to the end line.
- Should stay a few yards above goal line extended and move in and out without interfering with play and should never let players get behind him.

THE TRAIL:

- Responsible for watching for late hits after the shot.
- Should stay just inside the wing area a few yards above the top of the attack box.
- Responsible for the bench sideline and relaying all time-serving penalties to the table area.
- Watches the high crease area, especially one-on-one midfield play and picks above crease.
- Covers the midline for offside or other infractions when a loose ball approaches that area.
 - In this situation the Single MUST move up to release the Trail for transition.

NOTES

Never let the ball get behind you. Anticipate where the ball will be passed to next so you can back up from a play coming at you.

SETTLED COVERAGE



SETTLED SITUATIONS

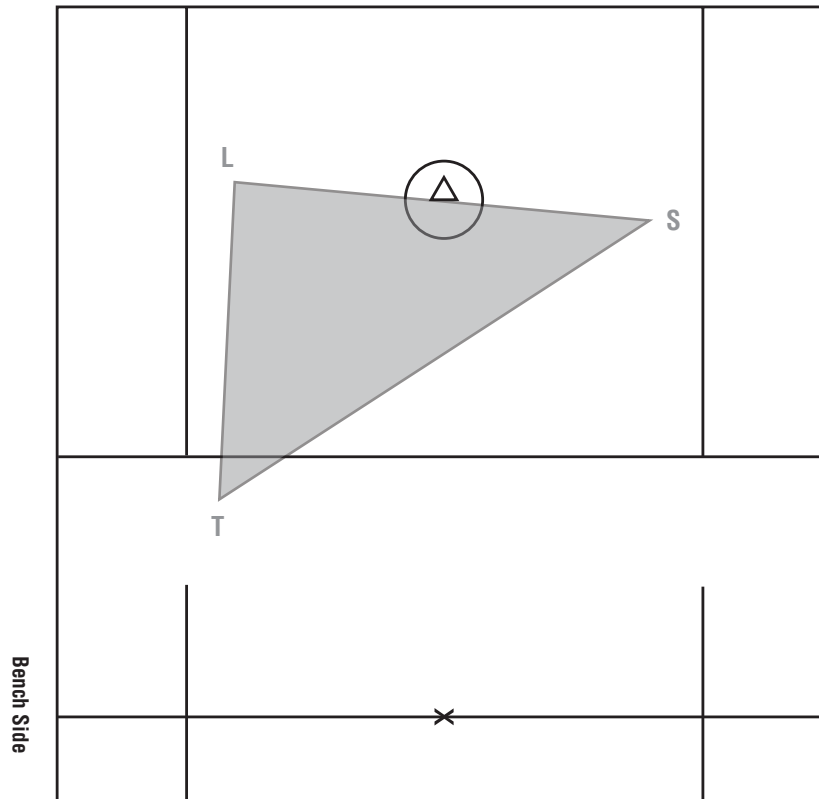

CREATE PLAY

BALL NEAR MIDLINE

BALL NEAR END LINE

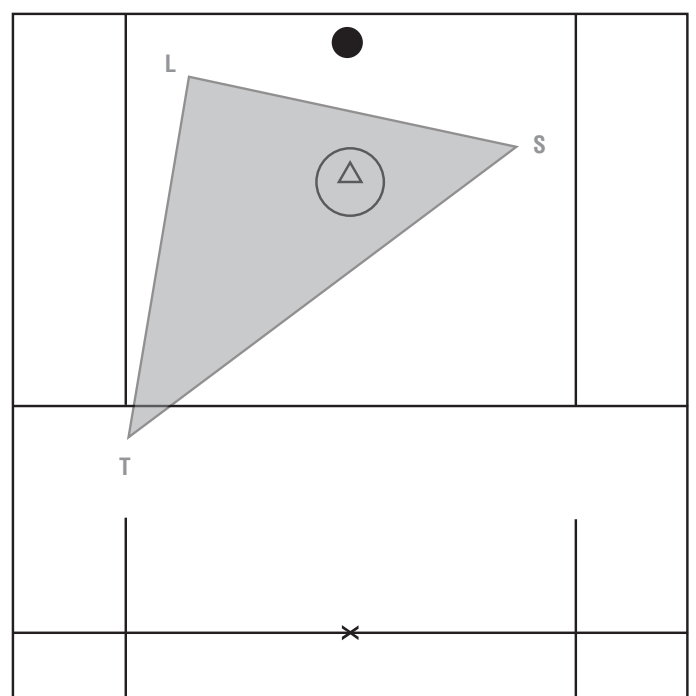
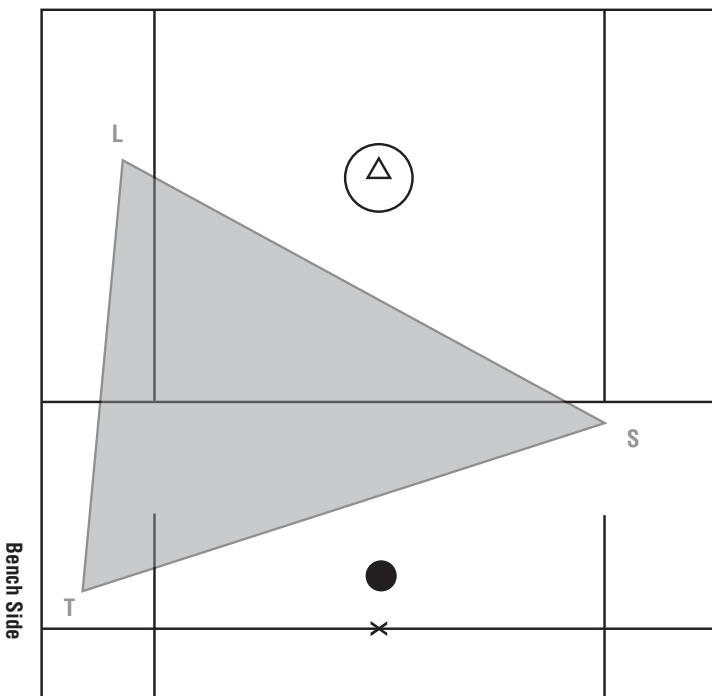

STOPPING AND STARTING PLAY

TO STOP PLAY:

- Each official is responsible for blowing the whistle if the ball (or the player in possession) goes out of bounds on the boundary line they are responsible for.
- When there is a play-on, the official calling the play-on is responsible for blowing the whistle to stop play if necessary.
- For a foul by the offense, the official witnessing the foul blows the whistle to stop play.
- When there is a flag down, any official noticing a condition for ending the slow-whistle situation blows the whistle to stop play.
- When a goal is scored, only the Lead should blow the whistle (unless the Lead does not see the goal and the Single does).

TO RESTART PLAY:

- Make sure that the player in possession is standing on the field, at least one yard in front of the sideline or 5 yards in from the sideline if he is within 10 yards of the substitution area.
- If the ball is leaving the Trail's half of the field, the Trail will usually have the whistle to restart play. If the ball is on the far side of the field the Single should hold one arm up until the player in possession is in bounds and out of the attack area; then the Single points in the direction of play. The Trail blows the whistle and the Single has the transition count.
- If the ball is possessed by the offense and is:
 - Coming in from the bench sideline, the Lead restarts play.
 - Coming in from the bench sideline and above the restraining line, the Trail official restarts play.
 - Coming in from the far sideline, the Single restarts play.
 - Starting on the end line in the attack area or in the Lead's alley, the Lead restarts play. Some Referees prefer to have the Single restart play on the end line in his alley; this should be covered in the pregame.
- The officials should make eye contact before most restarts to make sure they are ready - and in cases where it is questionable which official should whistle - to determine who is restarting play. If you want the whistle, point to yourself; otherwise, point to your partner.

NOTES

Count both teams before every slow restart.

Communication between the officials on restarts makes for a smoother game.



RESTARTS IN SETTLED SITUATIONS

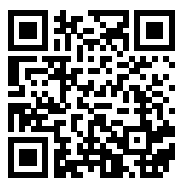

RESTARTS IN TRANSITION

RESTARTS - SETTLED SITUATIONS

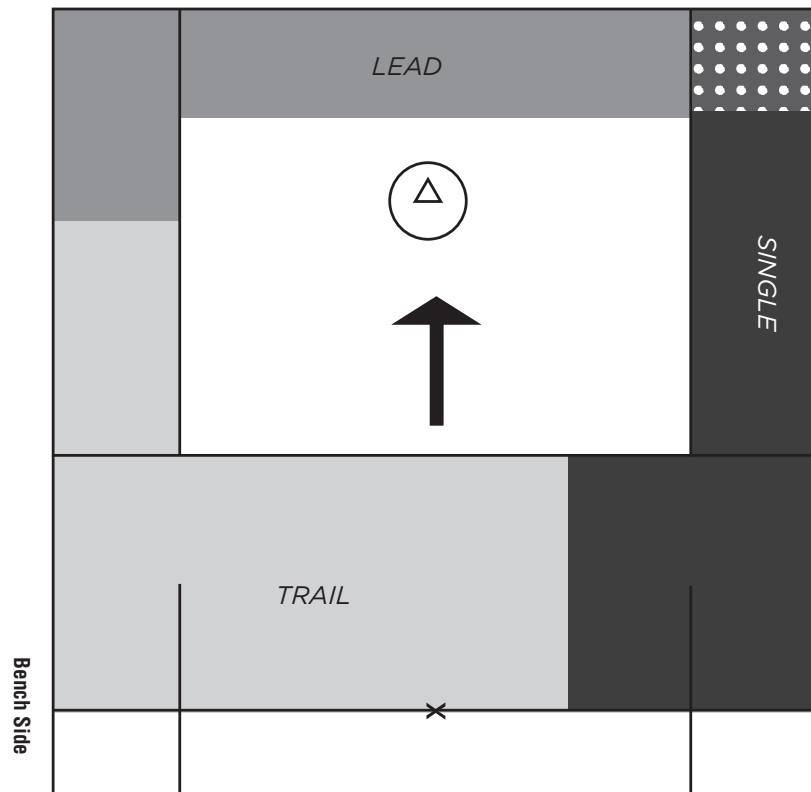

note: The dotted areas of the field represent overlapping coverage for restarts.

RESTARTS - TRANSITION

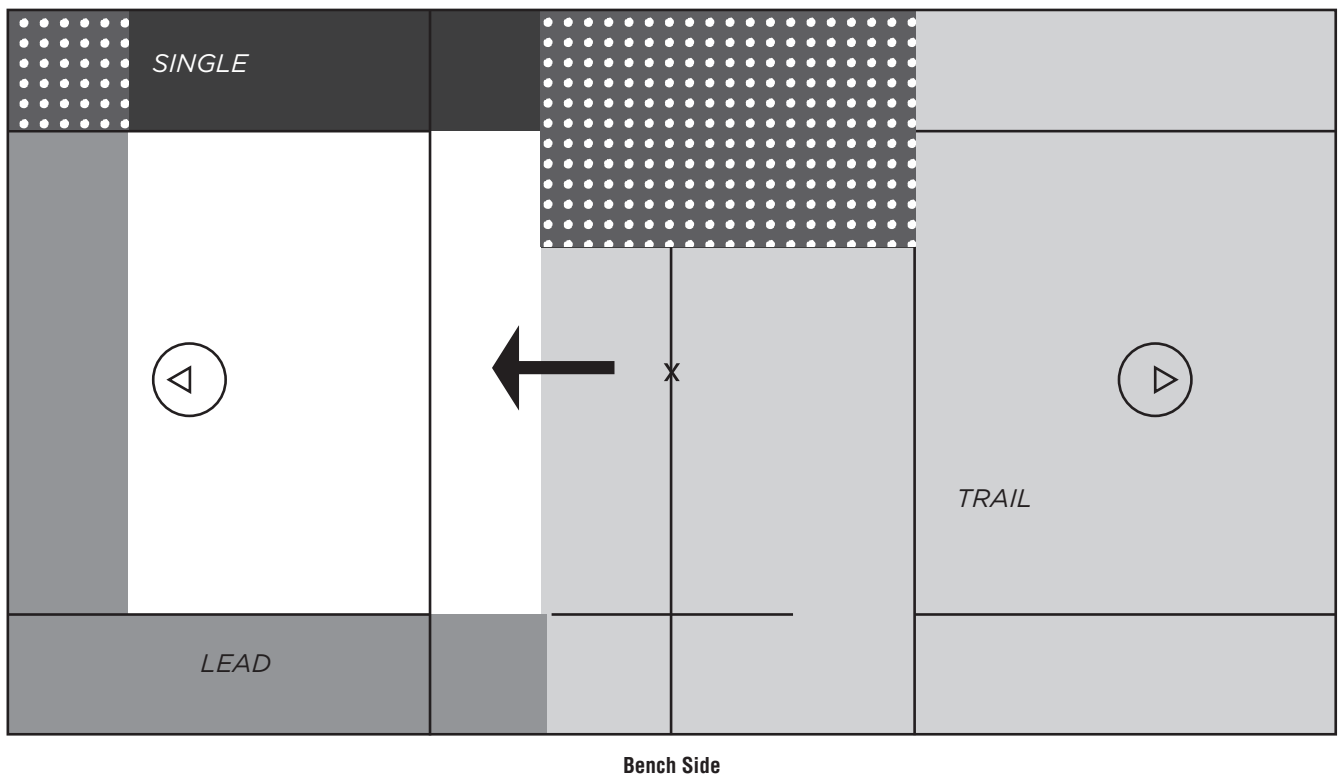

GOAL SCORED AND READYING THE BALL FOR THE FACEOFF AFTER GOAL

THE LEAD:

- Sounds the whistle immediately upon realizing the entire ball has passed beyond the goal line,
- Turns to face "action" in front of the goal, and gives the goal signal while stationary (1-2 seconds),
- Retrieves the ball from the goal, (Do not ask the goalie to get the ball out of the net for you),
- Jogs to Center "X" with the ball and becomes the faceoff official,
- Conducts faceoff duties as discussed earlier in this manual.

THE SINGLE:

- Waits for a whistle and goal signal by the Lead,
 - Only blows the whistle if the Lead has not seen the ball enter the goal.
- Moves towards the high crease area while watching for any fouls/late hits,
- Becomes new Lead Left or Bench Side Wing official depending on which side of the field the goal is scored on,
- Conducts faceoff duties as discussed earlier in this manual.

THE TRAIL:

- Waits for a whistle and goal signal by the Lead,
- Watches the shooter and crease area for fouls/late hits,
- Moves onto the restraining line and observes the whole field,
- Becomes new Lead Left or Bench Side Wing official depending on which side of the field the goal is scored on,
- Conducts faceoff duties as discussed earlier in this manual.

NOTES

On close goal calls near the crease the Single and Lead should look to one another to confirm a legal goal before the Lead signals.

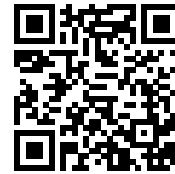

GOAL SCORED VIDEO

F/O AFTER GOAL LEFT SIDE

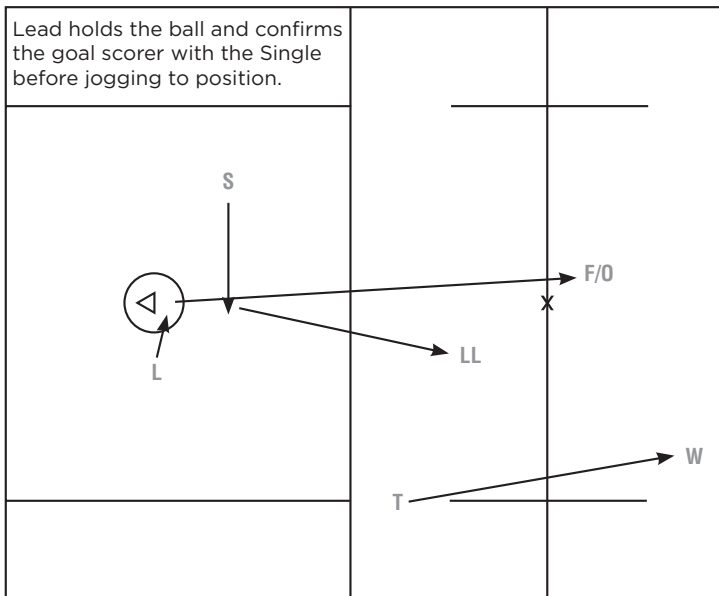

Bench Side

F/O AFTER GOAL RIGHT SIDE

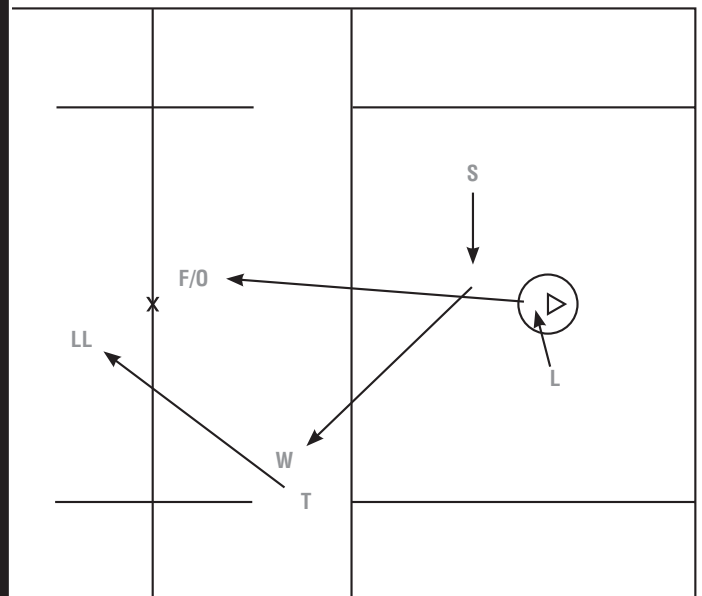

Bench Side

Trail official keeps eyes on all off ball action and any incoming substitutions while jogging back to become the lead

Trail official keeps eyes on all off ball action and any incoming substitutions while jogging back to a few yards inside the wing line.

NOTES

If you need to use a sweeping point it should be low and quick so as not to be confused with your immediate directional point.

OUT OF BOUNDS

Always attempt to position yourself in the best possible view of the play. Remember to stay outside of the play (you will often position yourself in the out-of-bounds area).

Use the following sequence of signals when you determine that the ball is out of bounds:

- Sound your whistle and signal “dead ball” (one hand over head with open palm) immediately when you determine the ball to be out of bounds.
- If the ball is out of bounds because a player stepped on the sideline or end line, give a sweeping point to the boundary line to indicate that the player stepped out.
- Signal the direction of the play by pointing in the direction play will be going and calling the color of the team that now has possession. Call only one color: say “Blue ball!”
- Allow any member of the team granted possession of the ball to take possession of the ball. Sound the whistle and wind your arm to restart the game if it is your restart.

note: The dotted areas of the field represent overlapping coverage.

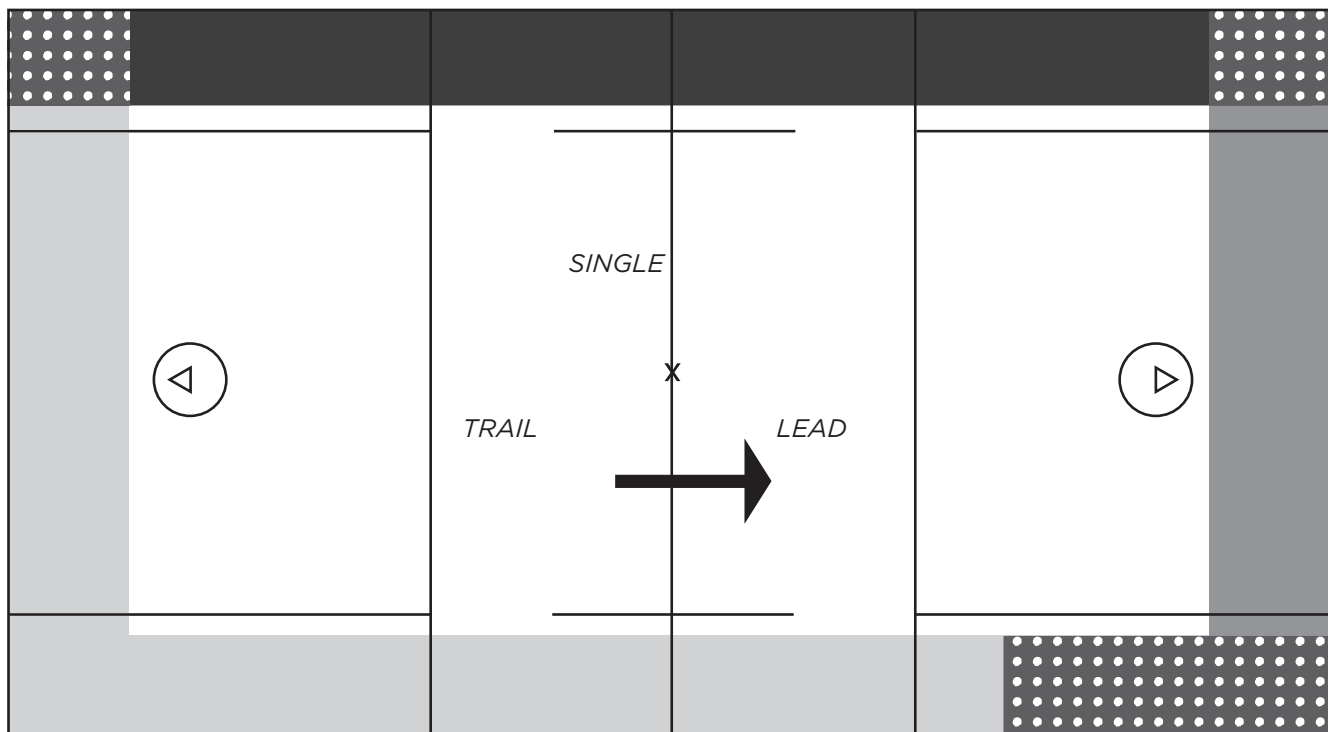

Bench Side

DEEP RESTARTS

THE LEAD:

- Has primary responsibility of covering his goal.
- Sets an initial position based on a variety of factors (e.g., the game situation, the teams' tendencies, the players' skills, his own mobility), but he will normally start at or near GLE.
- Must maintain visual communication with the Single (use hand signals).
- Signal "ready" when the field is ready.

THE SINGLE:

- Covers the midline for offside and keeps the transition count.
- Is positioned at the far cone straddling the midline and holds the position until the ball passes him (does not stop at midline on a fast break).
- Must maintain visual communication with the Lead and the Trail (Single is the quarterback for relaying "ready" signals to his partners).

THE TRAIL:

- Restarts the play, positioned slightly behind the ball.
- Is responsible for the 4-second count.
- Moves up the field with, but not ahead of, the ball in order to cover his goal if there is a turnover.
- Is responsible for late offside calls and checking that players are properly substituting after the ball crosses the midline.
- Must maintain visual communication with the Single (use hand signals).

NOTES

*Count forward when
determining offside.*

*Count players on offense
first. Then count the
defense.*

TRANSITION SLOW BREAK

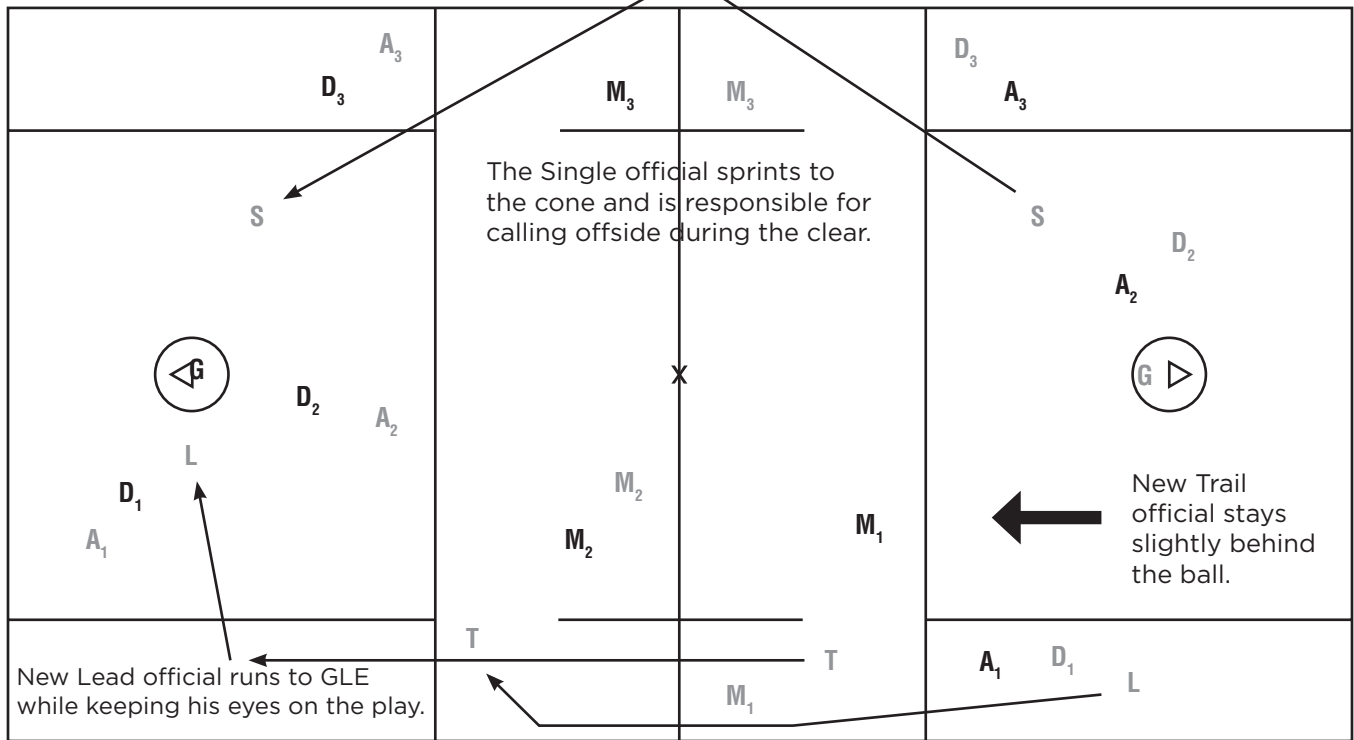

TRANSITION FAST BREAK

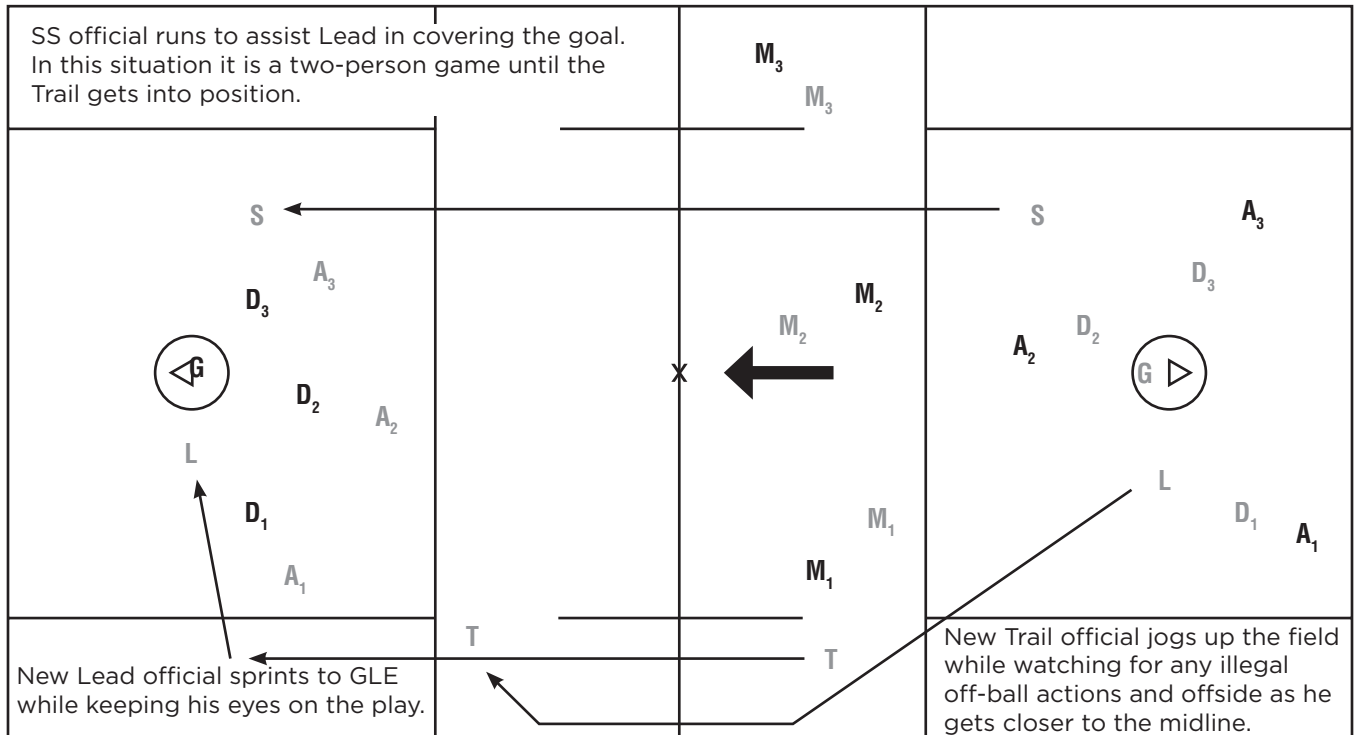

PENALTY ENFORCEMENT

Once you have determined that a foul has been committed, you must determine which of the following situations you are in:

- For loose-ball technical fouls (and also for most goalkeeper interference and crease violation fouls even if the ball is not loose), you will either employ the play-on technique or whistle immediately.
- For a foul by Team B when Team A has the ball yell “Flag down” and throw your flag straight into the air without blowing your whistle. Team A will have a chance to complete the scoring opportunity. Play stops when Team A scores a goal or when the rules require the official to whistle and stop play.
- For a foul by the team in possession, or for any loose-ball personal foul, blow your whistle immediately.

ONCE YOU SOUND THE WHISTLE, YOU SHOULD:

- Make sure the play is completed, including any dead-ball situations.
- Gather your thoughts.
- Check for flags from your partners. If there are multiple flags, determine if you have flags for the same foul or flags for two different fouls.
- The Trail official should report the penalty while the other officials set up the field for play.
- Position yourself with a clear view of the table along the wing line:
 - Set your feet before reporting and do not rush
- Signal the penalty using ‘C-NOTE’
 - Color, Number, Offense, Time, Explanation (if necessary)
- Ex. “Blue, 27, Slashing, 1-minute”
- After reporting, turn on your 20-second timer.

ENFORCEMENT AFTER A SLOW WHISTLE:

- A player that has committed a personal foul will always serve penalty time whether or not a goal was scored during the slow whistle.
- A player that has committed a technical foul will not serve penalty time if a goal was scored during the slow whistle.

LIVE BALL FOULS

Live ball fouls are ones committed during the play of the game. There are four possible scenarios, since there are both personal and technical fouls that can be committed during possession by either team or during a loose ball.

Personal and Technical fouls with possession by the team that was fouled:

- ALWAYS use the slow whistle technique
 - Throw the flag high into the air,
 - Yell “Flag down” AND allow the offensive team (with possession) to complete their play,
- Sound your whistle to stop play when the rules require you to do so,
- Make certain all residual action among the players has ceased,
- Report number of player and type of foul to your partners and the field,
- Relay penalty to the table and restart play.

NOTES

Relay your calls to your partners so everyone knows what to expect for the next restart.

When your partner says ‘flag down!’ repeat the call so the entire field knows that a flag has been thrown.

NOTES

When one of your partners says "flag down," repeat the call so the entire field knows that a flag has been thrown.

Being vocal is key; be clear and concise with all communications.

PENALTY ENFORCEMENT (CONTINUED)

Technical fouls during a loose ball:

- Use the "play-on" mechanic if appropriate,
- Sound your whistle to stop play if necessary,
- Make certain all action among the players has ceased,
- Announce foul, signal possession, and restart play.

Technical fouls with possession by the team committing the foul:

- Sound your whistle to stop play and make certain all residual action has ceased,
- Announce foul, signal possession, and restart play.

Personal fouls during a loose ball and personal fouls by the team in possession:

- Sound your whistle immediately to stop play,
- Throw the flag high into the air,
- Make certain all residual action among the players has ceased,
- Report number of player and type of foul to your partners and the field,
- Relay penalty to the table, and restart play.

DEAD BALL FOULS

Dead ball fouls are ones committed after play has been stopped (goal scored, timeout, period ends, whistle sounds for any reason), or after an action requiring a whistle occurs. There are four possible scenarios.

Personal foul by either team:

- Throw flag high into the air,
- Make certain that all residual action among the players has ceased,
- Report number of player and type of foul to your partners and the field,
- Relay penalty to the table and restart play.

Technical foul with neither team entitled to possession (after goal scored):

- Signal violation, signal possession, and restart play.

Technical foul by the team entitled to possession:

- Signal violation, signal possession, and restart play.

Technical foul by the team not entitled to possession:

- Throw flag high into the air,
- Report number of player and type of foul to your partners and the field,
- Relay penalty to the table and restart play.



PENALTY RELAY VIDEO

FOULS DECISION TREE

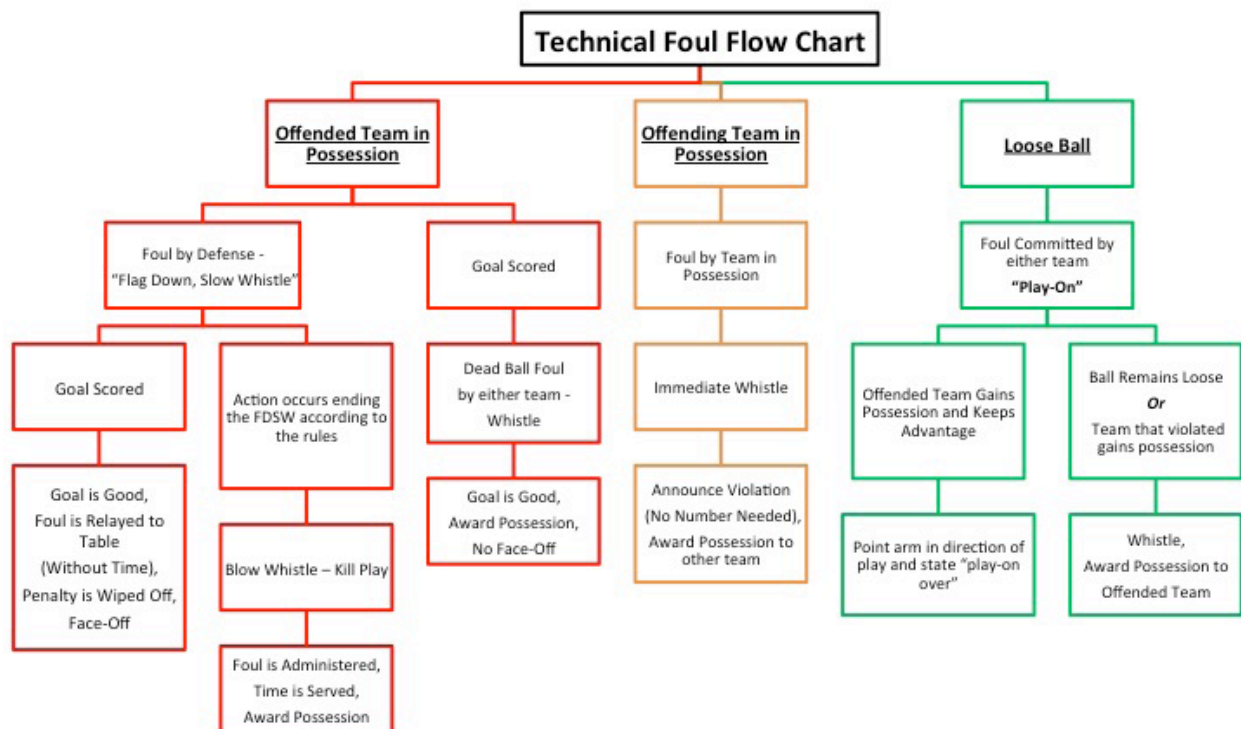
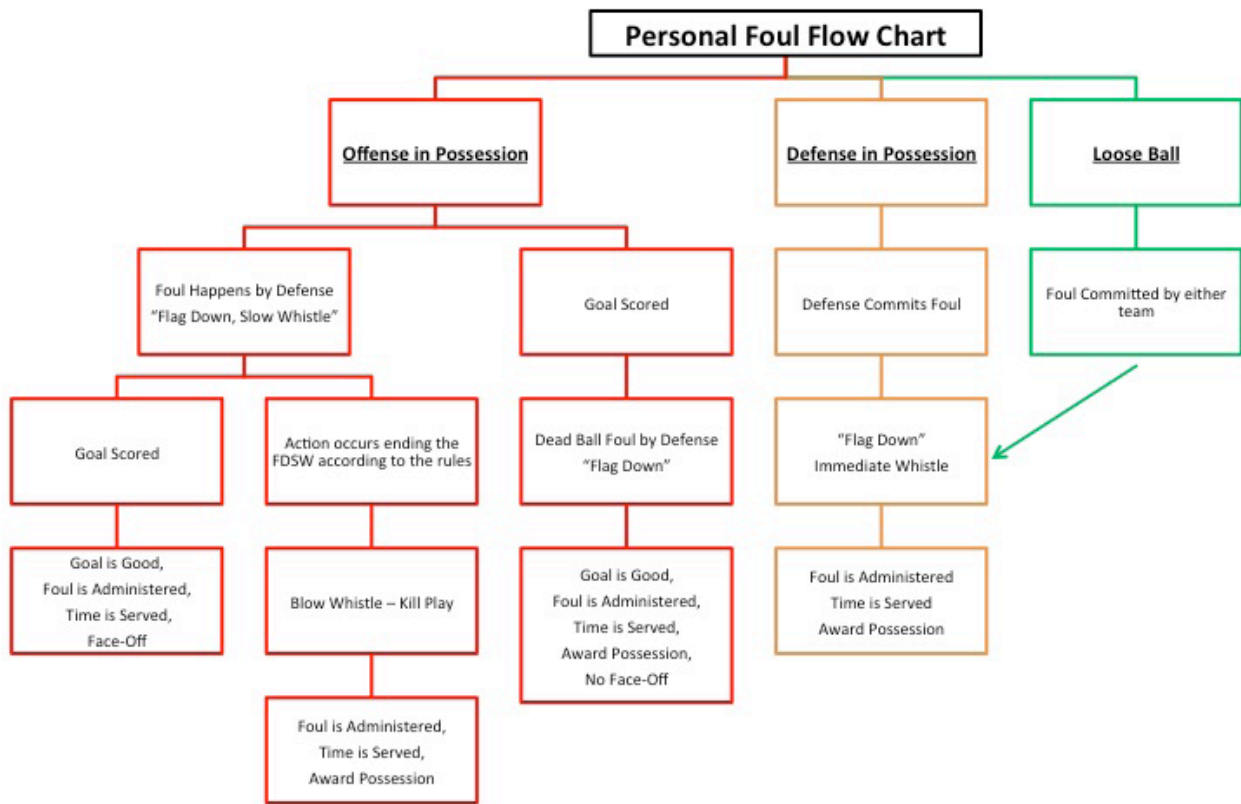

NOTES

*Keep the play-on short.
If no advantage or
disadvantage you should
stop the play immediately.*

PLAY-ON

PLAY-ON TECHNIQUE

If a player commits a loose-ball technical foul or crease violation and the offended player's team may be disadvantaged by the immediate suspension of play, the official shall visually and verbally signal "Play-on." The whistle shall be withheld until the play ends or advantage is gained or lost.

The play-on is intended to allow the game to flow. It makes no sense to stop the game for a loose-ball technical foul and then award possession to the team that is about to gain possession anyway. This is particularly true if the team that was fouled had an opportunity to create a fast break. When the ball is loose outside the crease:

- If one team has an opportunity to gain a clean possession and the other team commits a technical foul, use the play-on technique.
- If one team is about to gain possession and the other team commits a technical foul or line violation, but the team gaining possession would quickly be disadvantaged by going out of bounds or being trapped by opposing players, sound an immediate whistle.

ENFORCEMENT OF PLAY-ON

The play-on technique allows play to continue if the fouled team is not disadvantaged by ongoing play. This improves the flow of the game by reducing the number of stoppages, and it should only be used when it is advantageous to the team that was fouled.

When a play-on is appropriate for a loose-ball foul (and some crease violations and goalkeeper interference penalties with possession), the official shall raise one hand overhead and yell "Play on!" For a typical loose-ball foul, the whistle will be withheld until:

- Several seconds pass with neither team gaining possession.
- The team that committed the foul gains possession.
- The team that was initially fouled commits a foul.
- Any other action occurs that requires the officials to blow the whistle.

Once the whistle is blown, the official signals the loose-ball foul and awards possession to the team that was fouled to begin the play-on. However, if the fouled team is able to gain possession, the play-on is over and play continues without a stoppage. When this happens, the official should drop the raised arm, and point in the direction of the play and simultaneously state "[team color] ball!" so that everyone knows the play-on situation is over." Ex. "Blue ball," while pointing in the direction that the blue team is attacking.

OVER AND BACK

The over-and-back foul is a technical foul against an attacking team that results in a play-on in favor of the defending team. Once Team A (attacking) has successfully advanced the ball into the attack area to satisfy the clearing count, Team A has an obligation to keep the ball on its offensive half of the field while attacking. If Team A was the last team to possess the ball and the last team to touch the ball, and if the ball (not on a shot) either touches the midfield line or breaks the plane of the midfield line, then an over-and-back foul has occurred.

- The trail official will usually be in the best position to detect an over-and-back situation.
- If the ball approaches the midfield line, the other official(s) can yell “yes, yes, yes” or “no, no, no” to alert the trail official if there is a possibility of an over-and-back foul. “Yes” indicates there is a possibility of an over-and-back foul. “No” signals that the defense touched the ball last or that the defense possessed the ball momentarily, which would cancel the previous offensive clear by Team A and commence a new defensive clearing count for Team B.
- In addition to the “yes or no” audible signals, the officials might consider using the hand signal for “deflected” or “tipped” if the defense touched the ball last. The official(s) might also consider yelling “tipped” or “defender touched” while making the hand signals.
- The choice of audible and visual hand signals to be used for the over-and-back situation should be discussed during the officials’ pre-game meeting.

In most situations, the play-on will be terminated quickly unless Team B does not have a clear and obvious advantage to gain possession of the ball and continue its counter-attack.

- The trail official must watch carefully to ensure that a Team B attacker standing at the midfield line does not touch the ball first before the ball crosses midfield.
- If the over-and-back occurs and no advantage exists for Team B, then whistle the play dead quickly. Then conduct a restart from midfield.
- Bring the ball back to midfield for the restart.

NOTES

During the pre-game meeting with your crew, discuss how you want to use audible and hand signals for a potential over-and-back situation

Don't allow one team an unfair restart advantage.

If the ball squirts forward during a play-on and if you have to whistle the play dead, then bring the ball back to midfield for the restart.

NOTES

You can never over-communicate as it relates to team's getting a touch into the attack box or assessing a potential over-and-back situation.

Remember that a restart cannot be conducted if the ball carrier is within 5 yards of a teammate or an opposing player.

OVER AND BACK (CONTINUED)

Considerations when dealing with a potential over-and-back situation:

- The touch into the attack box - Make sure the attacking team got its touch into the Attack Area. If the attacking team has not gotten its touch into the attack box, then there cannot be an over-and-back foul. Officials must communicate clearly whenever an attacking team completes its clear with a touch into the attack box.
- Who touched the ball last? - Did the pass get deflected by the defense? If so, then there is no over-and-back call unless a Team B defender touches the ball before it crosses the midfield line. However, there is the chance of an offside or a push from behind causing an offside.
- Did the ball break the plane of midfield before being touched by a player from Team B? - If so, then play-on in favor of Team B. If the ball does not touch or go over the midfield line, then no infraction has occurred. Defensive players may legally bat the ball to keep it in the offensive half, but if the defensive player possesses the ball even for a second, then it is an over-and-back infraction even if the ball stay outside.
- Offsides - Is one team offside? Did one team go offside first? If so, then play-on. If simultaneous offside, then kill the play and award possession of the ball using the Alternate Possession rule.
- Pushing - Was there a push from behind causing a player to go offside?
- Interference - Did a player make contact with an opponent before the ball was within 5 yards? If so, then play-on for interference. Team B attackers will be trying to lift the sticks of the Team A long poles to create an over-and-back situation. Early contact is a play-on.
- Pre-game discussions for the over-and-back foul: Who kills the play? Who restarts the play? Where does the restart happen? When do we restart play (NFHS all players must be 5+ yards from a restarting player; NCAA restart if defense if within 5 yards and look for "delay of game" infraction if defender does not establish 5 yards before making a play on the player.)

EQUIPMENT CHECKS

Whether a check is being conducted at the request of the opposing coach or as a result of a routine inspection, the crosse inspection procedure is identical. Both must be done during a dead-ball situation. You must always verify all aspects of the player’s equipment and crosse if the coach requests an inspection.

- Go to the player whose crosse you’ve decided to check. Identify him by number and ask for his crosse.
- He may not touch the strings or jam the head once you have requested his crosse. If he seems about to do either, caution him not to; if he does so anyway, assess a 1-minute non-releasable unsportsmanlike conduct penalty and continue with the inspection.
- Any attempt by the goal scorer to adjust the pocket depth using a drawstring after a goal will be penalized with a 1-minute unsportsmanlike conduct penalty and the goal will be disallowed, even if the adjustment occurs before the official asks for the crosse.
- For coach requested checks (and for routine checks under NFHS rules), quickly check to make sure the player has a legal mouth guard, shoulder pads, arm pads, gloves (palms and fingers cannot be cut out), helmet, and cleats. If any required gear is illegal or missing, he receives a 1-minute non-releasable personal foul penalty.
- Take the crosse and move away from the player being inspected.
- Use the game ball to check the first three aspects of the crosse:
 - Place (don’t jam) the ball into the pocket and hold the crosse parallel to the ground at eye level. If you can see the top of the ball beneath the bottom of the sidewall, the pocket is illegal.
 - Again, place the ball into the pocket and rotate the crosse slowly forward from a vertical orientation to verify the ball freely rolls out of the crosse.
 - Finally, place the ball into the pocket and rotate the crosse slowly forward from a horizontal orientation to verify the ball rolls out of the top end of the crosse.
- Next, use your tape measure to check the measurements:
 - Measure the total length of the crosse along the handle from end of the stick to the very end of the head.
 - Measure the inside edges of the head at its widest point.
 - Measure the length of the inside of the head from plastic to plastic.
 - Measure the length from the top of the head to the shooting strings.

NOTES

*Umpire and Field Judge
face the benches.*

*Official nearest the
ball when the play ends
should bring the ball to
the equipment check.*

NOTES

Practice until you can check a crosse in under 30 seconds.

EQUIPMENT CHECKS (CONT.)

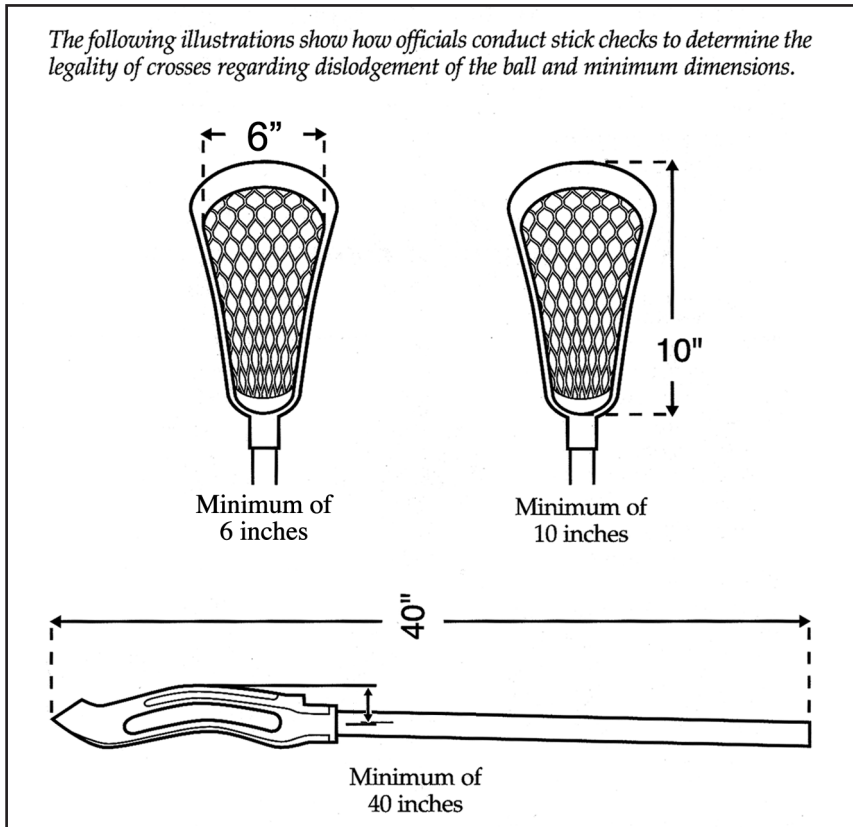
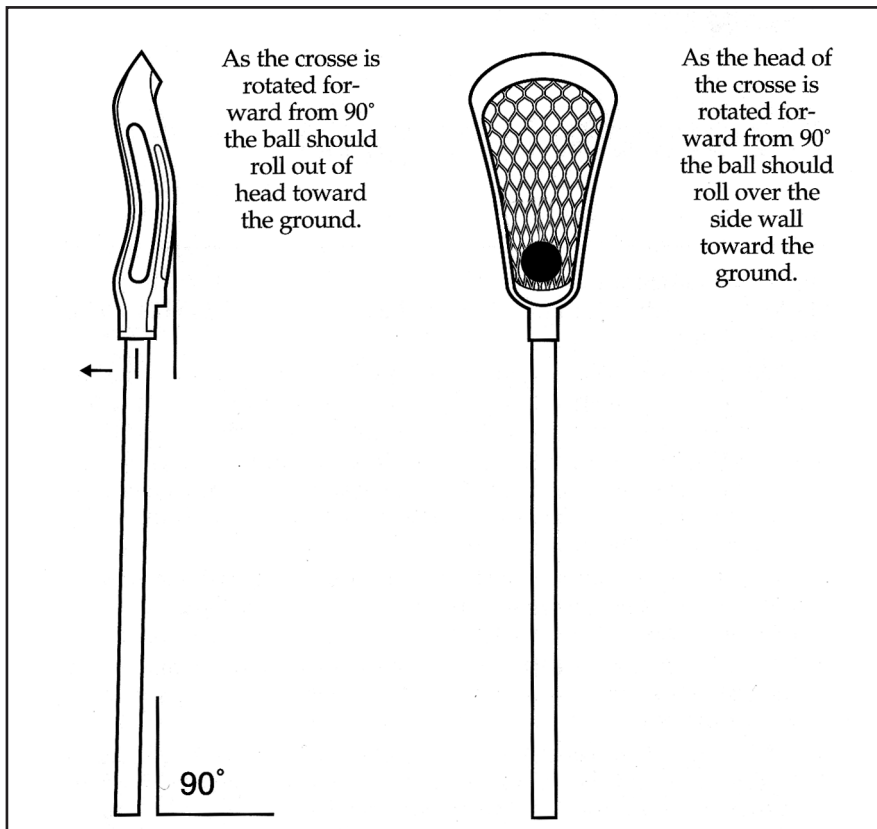

NOTES

The bench-side official should get to the wing line to watch the player crossover.

TIMEOUTS

OFFICIAL TIMEOUTS

- An official may suspend play at any time at his discretion for any reason he deems necessary for the proper enforcement of the rules or conduct of the game including issues with the players, coaches, spectators, table, field or weather. The Referee should notify the other officials, table and both coaches as to the reason for the game stoppage.
- Loss of Equipment - the official will stop play and allow the offensive player to fix the equipment issue and re-start outside the attack box. If the player is not involved in the action, the player can fix the equipment issue or substitute for another player that is fully equipped.
- Injured player - the official will stop play if the injured player is in the play or in the attack area. If the official deems the injury to be serious, the player will stop play immediately. The official closest to the player should approach, but should not touch or assist the player. The official nearest the bench should notify the coaching staff/trainer. If the uniform has blood on it that cannot be removed, he may change numbers as long as the table and other team are notified. An official timeout due to a player injury will not be charged a timeout to either team.
- Concussions - any player who exhibits signs, symptoms or behaviors consistent with a concussion (such as loss of consciousness, headache, dizziness, confusion or balance problems) shall be immediately removed from the game and shall not return to play until cleared by an appropriate health-care professional. Also note the NFHS Suggested Guidelines for Management of Concussion, in the NFHS Rule Book.
- Mistakes by an official should be corrected as quickly as possible. The Referee should correct the mistake, notify the table and coaches. The Referee must also allow or disallow the goal depending on the circumstances.
- If a player, coach, spectator or any other person is ejected from the game and needs to be removed from the premises. The Referee will be in contact with the Game Administrator and, if necessary, security and/or law enforcement. The other official will monitor the field and have the ball ready for restart.

TEAM/PLAYER TIMEOUTS

- During a play a timeout may be called by a team on the field or head coach according to when the rules permit. The official nearest the person calling the timeout (usually the Trail) should stop play and then notify the table and start his timer. The Trail should also position himself near the substitution box to prevent any player issues while the other officials are getting the ball ready for play. The official should then confer with the table to verify the remaining timeouts for the teams and confirm with the crew.
- At 1 minute and 40 seconds, the bench official (who will be Trail for the restart) should blow whistle for the teams to return to the field and start the timer.
- Coaches and teams should remain in their respective coaching areas and not come onto the field during the timeout.
- Each team is allowed one illegal-equipment request per game unless an illegality is found during that check or an ensuing one.
- Each team can call for a double horn at a dead ball situation and request a count of the long poles on the field. If the head coach makes a second request where the long poles were correct, the team is penalized.

FIGHT PROCEDURES

FIGHT MECHANICS

- The “on” official nearest the incident:
 - Tries to clear other players from the altercation.
 - Attempts to break up the fight by giving verbal commands and blowing the whistle repeatedly.
 - Verbally warns other players not to get involved, even as “peacemakers”
 - Tries to remember the color and numbers of all players involved and, if possible, the sequence of involvement.
- The closest “off” official:
 - Gets to the area near the fight as soon as possible and assists the “on” official in keeping players on the field from getting involved.
 - Should note the numbers of players in the fight or entering the fight and write them on his card, if necessary.
- The furthest “off” official:
 - Takes a position on the field in front of the benches.
 - Directs coaches to keep their players and fans off the field, “Freezes the benches.”
 - Records the numbers of any players entering the field from the bench area and mentally notes which coaches enter the field.
- After the incident:
 - Send all players to the bench area.
 - Direct coaches to get their players together, and get them under control.
 - Take a deep breath, and be sure to look calm and in control.
 - Take your time. Don’t feel rushed to get the game under way until you have completed all of the following steps completely.
 - Meet with other officials to determine the fouls and sequence while continuing to observe the field and the players.
 - Meet with the scorer before announcing penalties to provide time to record penalties and clearly define who will be on the field for the restart.
 - Announce penalties (mandatory expulsion with 3 minutes of non-releasable penalty time for striking another person or leaving the bench area; other penalties discretionary).
 - Clearly communicate your expectations about behavior to both benches and to players in the penalty area. Warn both teams that the game is in danger of being terminated.
 - Feel free to terminate the game if you feel absolute control cannot be regained.
- After the game (assigned Referee only):
 - Prepare written report, including the game conditions, the players involved, a description of the incident, and the resulting penalties.
 - Call your assignor; review the incident.
 - In all communication regarding any expulsion or incident, limit your remarks to the facts at hand and what you saw. For example, “Blue number 32 kicked White number 10 (who was lying on the ground) in the chest” speaks only to the facts of the incident. Do not say something like “Blue number 32, who is a dirty player and who is always causing trouble, was angry because White number 10 had just scored a goal, so he kicked him to try to get even,” which is filled with opinion and speculation.
 - Send DRAFT of game report to your partners and your assigner to check for accuracy, facts, etc... BEFORE submitting official game report.

NOTES

Get big and loud to freeze the benches.

There is no rush to restart play after a fight.

NOTES**POST-GAME****DEBRIEFING, LESSONS LEARNED AND IMPROVING YOUR GAME**

Officials can't learn from mistakes unless mistakes are made. You will make plenty of them as you learn how to officiate the game. The trick is not to repeat them. But because mistakes are a part of the game, you will want to learn as much as you can from these errors. Post-game analysis is often difficult to conduct immediately after the game, when people have to get back to their families or other obligations. Some suggestions:

- You can control the kind and the amount of feedback that you get by the way that you react to the information that you've requested. If you request feedback, be open to it and listen to what is said rather than challenge the people who you ask to assist you.
- Rather than just asking how you did, ask specific questions. Here is a sample dialogue: "Do you remember that illegal body check call that I had in the third quarter? What did you have? Tell me why you would or wouldn't have made that call."
- Propose going somewhere to buy your officiating partner a soda, even if it is to a gas station on the way out of town. Then you can take a few minutes to clear the air regarding the game.
- Ask permission to call your officiating partner at night to discuss.
- If you have a mentor, be sure to check in with this senior official for feedback.
- Keep reading the rule book, focusing on Rules 4, 5, and 6 (and also the "play on" and "slow whistle" portions of rule 7). As you do this, you'll continually find situations that you saw in your games and didn't know how to handle. Be sure to read the situations in the rule books as well as the rules themselves.
- Continue your officiating education regularly through your local officiating organization and practice, practice, practice!

ARM SIGNALS

DIAGRAM

OFFICIAL'S MOTIONS

PERSONAL FOULS



PERSONAL FOULS

Personal fouls are those of a serious nature and will result in a man advantage. The emphasis on safety and sportsmanship in youth lacrosse is expressed in stricter enforcement of personal fouls. Official points index finger upwards and blows whistle

An offending player's team will be a man down while he serves his penalty in the penalty box. A personal foul can be one, two, or three minutes, depending on the official's judgment of the severity and perceived intent of the foul. Fouled team will be given possession.



ILLEGAL BODY CHECK

Elbow is brought horizontal to shoulder with hand on chest and then moved up-and-down

NO body checking of any kind permitted in U9 and U11

Take-out checks NOT ALLOWED at any level, ever!

Fouls will be called for a body check:

- of an opponent without possession of the ball or more than 3 yards from a loose ball.
- delivered without both hands on the stick
- avoidable hit on opponent who's already passed or shot the ball.
- to a player from behind, below the waist or above the shoulders, including following through to head.
- to a player with any body part other than their feet on the ground.
- initiated with the head, also known as spearing and assessed a non-releasable penalty.
- considered more aggressive than necessary to knock to the ground, injure the player or made in a reckless or intimidating manner.



CROSS-CHECK

Pushing the arms away from body in a parallel fashion

A player cannot use the stick shaft between his hands to play an opponent, either when thrust against his opponent or striking him while running with his stick extended.



DEEP POCKET

Pointing toward the illegal pocket

A player may not use a stick that doesn't conform to specifications. For example, it is a:

- 1-minute non-releasable penalty if a stick has too deep a pocket or weaving not firmly attached.
- 3-minute non-releasable penalty for any other reason and stick is removed for balance of game.



ILLEGAL CROSSE

Pointing toward the illegal stick







ILLEGAL EQUIPMENT

Pointing toward the illegal equipment or where it would be on the player

A player may not use equipment that doesn't conform to specifications. For example: cutting palms out of gloves or altering protective equipment like shoulder and arm pads, non-regulation lacrosse helmets and mouth guards, Jewelry, unless religious or medical alert items taped.

ARM SIGNALS

DIAGRAM	OFFICIAL'S MOTIONS	PERSONAL FOULS
	<p>SLASHING Intersecting arms. One arm chopping the other, normally at face height</p>	<p>A poke into the ribs, chest, neck or back. A vicious, uncontrolled swinging the stick, whether contact is made or not. The gloved hand on the stick may be legally checked.</p>
	<p>TRIPPING Swinging one arm at knee level</p>	<p>A player may not trip an opponent with a positive action of his body or stick below the waist resulting in their being obstructed.</p>
	<p>UNSPORTSMANLIKE CONDUCT Arms extended from shoulder height</p>	<p>Non-releasable - arguing with official, using threatening or obscene language or gestures, baiting or taunting, or any other act officials deem unsportsmanlike.</p> <p>Releasable - repeatedly committing same technical foul, not returning to field immediately, and a substitute deliberately not complying with rules for entering game.</p>
	<p>UNNECESSARY ROUGHNESS A salute motion</p>	<p>Any excessively violent infraction of the rules governing holding or pushing. Includes checks delivered with a punching blow, against a player setting a pick or a stationary defender and checking an opponent who is in a vulnerable position.</p>
	<p>FOULING OUT No specific signal for foul Whistle with arm straight up or ejection motion often used</p>	<p>A player, substitute, coach or other team personnel can be ejected from the game for serious infractions. See ejection foul page for further details. Ejection fouls are enforced with a three-minute non-releasable penalty.</p>
	<p>EJECTION Thumb Up, hand moves up over shoulder</p>	<p>A player, substitute, coach or other team personnel can be ejected from the game for serious infractions. See ejection foul page for further details. Ejection fouls are enforced with a three-minute non-releasable penalty.</p>

ARM SIGNALS

DIAGRAM

OFFICIAL'S MOTIONS

TECHNICAL FOULS



TECHNICAL FOULS

Technical fouls are fouls of a less serious nature and include all violations of the rules except those listed as personal or ejection fouls. Signal only if time being served. Arms placed in a "Tee" formation at chest level.

The penalty for a technical foul is either:

- 30 second releasable penalty after flag-down, slow-whistle if fouled team had possession at the time
- Possession awarded to fouled team after play-on ended
- If ball remains loose, fouled team awarded ball at spot of infraction



CREASE VIOLATIONS

Sweeping motion of the arm towards the crease

Usually from stepping into the crease while on offense.



HOLDING

Grasping a wrist with the opposite hand and using a vertical pumping motion

Numerous violations, which include holding an opponent with a free hand and holding the body of an opponent with a stick.



ILLEGAL OFFENSIVE SCREENING

One hand bent at elbow extending up and the other hand moving toward elbow

Teammate moving or stepping into opponent while trying to screen a player guarding a teammate.

Often referred to as a "moving pick," no offensive player shall move into and make contact with a defensive player with the purpose of blocking a defensive player from the man he is playing.

Called only when one offensive player checks a defensive player when the checker's team has possession.



PUSHING

One hand against body and other hand makes a pushing motion away from body

A player shall not thrust or shove an opponent from the rear. Pushing is permitted from the front or side when an opponent has possession of the ball or is within 3 yards of a loose ball.









ILLEGAL PROCEDURE





Forearms horizontal at chest level rotating around each other

Any number of actions on the part of players or substitutes of a technical nature that are not in conformity with the rules and regulations governing the play of the game shall be termed illegal procedure.

ARM SIGNALS

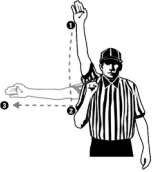
DIAGRAM	OFFICIAL'S MOTIONS	TECHNICAL FOULS
	CONDUCT FOUL One arm held extended from body at shoulder height	Aggressively object by arguing or gesturing to a decision by an official. Coaches or players not in their designated area. Any act considered misconduct by an official.
	INTERFERENCE Hands crossed over the chest	Contact not within five yards of a loose ball. A player shall not interfere in any manner with the free movement of an opponent when his team has possession.
	OFFSIDE Both hands on hips	Too many players in either end of the field.
	STALLING/DELAY OF GAME Hands clasping forearms at stomach level	A stalling violation will be called if the ball leaves the goal area after the stall warning, unless it's from a shot deflected off the goal, goalie or a pass that is deflected by a defensive player.
	WARDING OFF Fist near chest while moving elbow up	A player in possession of the ball shall not use his free hand or arm or any other part of his body to hold, push or control the direction of the movement of the crosse or body of the player applying the check.
	WITHHOLDING BALL FROM PLAY Arms extended from body with one hand covering the other	Lying or sitting on a loose ball. Clamping a ball longer than necessary to pick it up.

ARM SIGNALS

DIAGRAM	OFFICIAL'S MOTIONS	PROCEDURAL FOULS
	<p>GOAL SIGNAL Turns toward center of field, arms raised and then lowered.</p>	<p>The goal line official calls all goals. The ball must pass completely through the plane of the back edge of the pipes. Hitting two or three pipes does NOT designate a goal.</p>
	<p>NO GOAL Arms extended toward the ground and swung out-and-in so that they cross each other.</p>	<p>Goals that are scored illegally are quickly reversed by the official.</p>
	<p>TIMEOUT Turns towards the timer and crosses fully extended arms at the wrist above the head.</p>	<p>The official will alert the timekeeper when to stop the clock. In games that use running time, certain conditions like legal timeouts, injury timeouts and equipment checks will require the clock to be stopped.</p>
	<p>DIRECTION OF POSSESSION Arm is raised horizontally at shoulder level and pointed towards the goal of the team awarded possession</p>	<p>The official will indicate the direction of play when either the ball goes out of bounds or there is a loose ball technical foul that results in a change of possession.</p>
	<p>OFFENSIVE STALLING WARNING One hand vertically up and the other arm pointing towards goal</p>	<p>Attacking team is not making an effort to attack the goal and score.</p>
	<p>FAILURE TO ADVANCE Hand over head, palm down, with a tapping motion</p>	<p>Failure to advance the ball over the midfield line in 20 seconds or to bring the ball into the goal area within 10 seconds after crossing the midfield line can result in a turnover.</p>
	<p>LOOSE BALL Two hands pointing down at the ground</p>	<p>Indicates that the ball was loose when there was a technical foul.</p>
	<p>PLAY-ON One hand extended above shoulder into the air</p>	<p>If a player commits a loose-ball or line violation foul, goalie interference or crease violation and the offended player may be disadvantaged by the immediate suspension of play, the official will delay the whistle and signal play-on.</p>



APPENDICES

APPENDIX I: AVAILABLE TRAINING TOOLS

USLACROSSE.ORG/OFFICIALS/MENS-OFFICIALS-MORE-RESOURCES

<p>GENERAL RESOURCES</p> <ul style="list-style-type: none"> • Coaches Certification Cards • Youth Officials Pre-Game • New Adult Officials Pre-gam • 2-Person Crew Pre-Game • 3-Person Crew Pre-Game • Uniform Requirements • Game Bag Tips • Scorecard • Fouls Decision Tree • Insurance FAQ 	<p>ELEARNING AT LEARNING.USLACROSSE.ORG</p> <ul style="list-style-type: none"> • Boys' Lacrosse Rules Online Course • Professional Development <ul style="list-style-type: none"> o 2-Person Mechanics o 3-Person Mechanics o A Big Call is Still Just a Call o Analogies to Raise Your game o Coach and Official Perspectives o Crease Play o Family of Fouls o Game Management o Leadership in Officiating o The Ramp o We Can't Do This Alone • Development Clinic Q&A
<p>MANUALS</p> <ul style="list-style-type: none"> • 2-Person Mechanics • 3-Person Mechanics • Game Management 	
<p>RULES</p> <ul style="list-style-type: none"> • Youth Boys' • NFHS • Field Diagrams 	



MEN'S OFFICIALS RESOURCES



MEN'S GAME VIDEOS



MEN'S ELEARNING

APPENDIX II: HOW OFFICIALS HONOR THE GAME

By getting coaches, parents, and administrators on the same page about Honoring the Game before the season starts, we hope to reduce the number of negative incidents that occur at youth games. However, even with the right training and expectations in place, negative incidents still happen. This is when it is particularly important for game officials to have a plan. Here are a few tips to get you started —please refer to the “Post Game” section for more information.

The PCA recommends that officials always introduce themselves to the coaches before the start of the game. Officials at youth games can remind coaches that they expect them to take responsibility for the conduct of their fans, and if there is trouble during the game with the fans, the officials will come to the coaches to ask for their help in taking care of this problem. Officials and coaches should view themselves as working together to create and maintain a positive environment for the players.

Unfortunately, on some occasions officials have to deal with abusive behavior from coaches. In these cases, where coaches are no longer Honoring the Game, officials bear the ultimate responsibility to ensure players are taking part in a safe and positive environment. Although it is neither fun nor easy, officials need to address abusive coaches in a calm and respectful manner to remind them that their conduct is inappropriate. If the situation persists, coaches should be warned that the game is in danger of being terminated.

By spreading the Honor-the-Game message to all involved in lacrosse, we hope to improve the game environment for officials, hence addressing the constant lack of officials. Officials should view themselves as an important adult group working to support a culture that Honors the Game, and they should feel joined in this effort by coaches, parents, and administrators. Positive Coaching Alliance and US Lacrosse are here to help you.

US Lacrosse asks you to consider your role in Honoring the Game, showing respect for all the people working together to make lacrosse the great game that it is. Take this simple test—and be sure you can check off every one before you head out to officiate:

___ I understand and will reinforce that the safety of the participants in the game is more important than the final score.

___ I understand that lacrosse officials do not make the rules, they only apply them.

___ I understand that children learn from adults, and my behavior reflects what I want children to learn.

___ I value the contribution of coaches in developing players’ talents, even though I may not always agree with their _____ strategies.

___ I understand that I must consider the level of play when officiating and respond accordingly.

___ I understand that the biggest reason for players (and officials!) quitting the game is verbal abuse.

___ I understand that players, coaches and officials are learning the game, and mistakes will be made in the learning _____ process.

___ I understand that officials are responsible for ensuring that the game is played in a safe and fair manner for all _____ participants.

Thank you for your help in the efforts to make lacrosse a positive experience for everyone!

APPENDIX III: US LACROSSE CODE OF CONDUCT

THE CODE OF CONDUCT

Players, coaches, officials, parents, spectators and fans are to conduct themselves in a manner that “Honors the Game” and demonstrates respect to other players, coaches, officials, parents, spectators, and fans. In becoming a member of the lacrosse community an individual assumes certain obligations and responsibilities to the game of lacrosse and its participants. The essential elements in this “Code of Conduct” are honesty and integrity. Those who conduct themselves in a manner that reflects these elements will bring credit to the sport of lacrosse, themselves, their team and their organization. It is only through such conduct that our sport can continue to earn and maintain a positive image and make its full contribution to amateur sports in the United States and around the world. US Lacrosse supports the following behaviors for those participating or involved in any way with US Lacrosse in general. The following essentials elements of the “Code of Conduct” must be adhered to:

- Sportsmanship and teaching the concepts of fair play are essential to the game and must be taught at all levels and developed both at home and on the field during practices and games.
- The value of good sportsmanship, the concepts of fair play, and the skills of the game should always be placed above winning.
- The safety and welfare of the players are of primary importance.
- Coaches must always be aware of the tremendous influence they have on their players. They are to strive to be positive role models in dealing with young people, as well as adults.
- Coaches should always demonstrate positive behaviors and reinforcement toward players, parents, officials and spectators alike. Players should be specifically encouraged and positively reinforced by coaches to demonstrate respect for teammates, opponents, officials, and spectators.
- Players should always demonstrate positive behaviors and respect toward teammates, opponents, coaches, officials, parents, spectators, and fans alike.
- Coaches, players, parents, spectators, and fans are expected to demonstrate the utmost respect for officials and reinforce that respect in his or her players. Coaches are also expected to educate their players as to the important role of the lacrosse official and to reinforce the ideal of respect for the official by his or her players.
- Grievances or misunderstandings between coaches, officials or any other parties involved with the sport should be communicated through the proper channels and procedures, never on or about the field of play in view of spectators or participants.
- Officials are professionals and are therefore expected to conduct themselves as such and in a manner that demonstrates total impartiality, courtesy and fairness to all parties.
- Spectators involved with the game must never permit anyone to openly or maliciously criticize badger, harass, or threaten an official, coach, player or opponent.
- Coaches must be able to demonstrate a solid knowledge of the rules of lacrosse, and should adhere to the rules in both the letter and the spirit of the game. Coaches should encourage and help to educate the players and spectators surrounding his or her program to develop a basic knowledge of the rules. Attempts to manipulate rules in an effort to take unfair advantage of an opponent, or to teach deliberate unsportsmanlike conduct, is considered unacceptable conduct.
- Eligibility requirements, at all levels of the game, must be followed. Rules and requirements such as age, previous level of participation, team transfers, etc, have been established to encourage and maximize participation, fair play and to promote safety.

APPENDIX IV: US LACROSSE BENEFITS FOR OFFICIALS

US Lacrosse provides a large number of benefits to its member officials, including:

- Men's game Lacrosse Referee Development (LAREDO) on-field officials development programs.
- Liability insurance.
- Discounts on lacrosse officials uniform starter packages.
- Game fee insurance (for when you are hurt while officiating and miss officiating scheduled games; contact Bollinger insurance for full details).
- Secondary medical insurance.
- A free copy of the NFHS or NCAA rule book each year.
- Online rules testing.
- A subscription to *Lacrosse Magazine*.
- Discounts through the US Lacrosse store.
- Free admission to the US Lacrosse Museum in Baltimore.
- Access to US Lacrosse training and materials, which is continually being improved and expanded.
- Access to the US Lacrosse Convention, held in January of each year, which provides a full program of officiating clinics.
- The men's game email newsletter (for collegiate officials).
- The men's game Resources Page, which houses a number of useful documents for men's officials.
- Membership in local US Lacrosse chapter.
- Annual men's game awards.
- Customer service support.
- Nationwide support for the development of the sport of lacrosse.

In order to continue to receive your benefits, you must keep US Lacrosse updated with your current email and home addresses. If you have a change to report, or if you think you are not receiving the correct correspondence from US Lacrosse, contact membership@uslacrosse.org.

You can join US Lacrosse online by going to uslacrosse.org



US LACROSSE MEMBERSHIP
INFO



US LACROSSE NATIONAL HEADQUARTERS

2 Loveton Circle, Sparks, MD 21152
410.235.6882 | uslacrosse.org